



Digital Torque Meters

HP-100 / HP-10 / HP-1 (Option)

Operation Manual

(November 2020)



Contents

• Applications and features of HIOS Digital Torque Meters	2	• Changing the Fidaptor shock absorber spring	10
• Safety Precautions	3	• Care of the Fidaptor	10
• HIOS Digital Torque Meter controls	4	• Fidaptor parts	11
• List of items included with torque meter and explanations of Fidaptor and threaded shaft	5	• Using the adapter socket for torque measurement of instruments other than screwdrivers	12
• Fidaptor	6	• Battery charger	12
• Operating instructions	7	• Types of data output	13
• How to measure screwdriver torque using the Fidaptor	7	• Customer service	13
• Explanations of functions	8–10	• Inspection and calibration	13
DIP switch	8	• Troubleshooting	14
Torque settings	8	• Specifications	14
Memory	9	• External features diagram	15
Average torque measurement	10	• Analog and serial data output specifications	15
		• China RoHS2 Table	16

However high the quality of your screwdriver, you cannot make full use of its potential unless you know the right amount of torque for each job and make sure that is the torque being delivered. With a HIOS digital torque meter you can make torque settings on screwdrivers, check torque wrenches or make torque measurements of various kinds of rotation tools. With an optional attachment, it is also possible to transfer measurement data to a computer for use in integrated production management systems.

Easy to use, accurate and low in cost, HIOS digital torque meters are used by manufacturers of electronic goods, cameras, watches and other kinds of precision instruments, as well as by makers of automobiles and aircraft.

■ Applications

- Torque measurement of power screwdrivers, torque drivers and torque wrenches
- Certification of performance of torque tools
- Torque measurement of other kinds of rotation tools (may require adapter)

Examples of uses of torque measurement data

- Reference for preparation of tap screw counterbore diameters
- Sorting screws by required torque values
- Classifying jars by screw cap tightness
- Destructive testing of small parts
- Quality control of plastic screw threads and plastic parts

■ Features

- HP-1 is on request product. It can be measured below 10N•cm.
- Up to 100 data measurements can be stored in memory at a time.
- Checks maximum, minimum and average torque measurements.

- Torque value display can be automatically reset to zero.
- Torque value display are automatically recalibrated.
- Values are displayed digitally for ease and accuracy in reading out data.
- Peak torque values are frozen until the display is reset to insure accuracy when setting torque of instruments.
- Can be set for rotation in either direction, for easy measurement of both tightening and loosening torque.
- Counterclockwise torque measurement is indicated by a minus sign in front of displayed values.
- The strain meter is directly attached to the torque sensor, as part of the instrument's simple, rugged design.
- Can be integrated into a statistical process control system.
- Small, light and operated by rechargeable battery, this instrument is highly portable.

- Data can be output analogically, as waveforms or numerical printouts, for a wide range of uses. (Requires optional analog cord.)
- An input tool is available to make possible transfer of measurement data to a computer. (See page 13 for details.)
- Comes with an AC adapter that can be used with 100 — 240 volt power sources. Runs on an environment-friendly nickel-hydrogen battery.



Safety Precautions

Please read the following safety precautions to ensure safe and correct operation.

■ Before using

- Before you begin using the instrument, read the operating instructions and also the precautions given on the seal affixed to the instrument.
- HIOS cannot assume responsibility for accidents or difficulties when the instrument has been remodeled or disassembled, or when it has been used in a way other than that explained in the operating instructions.

■ During operation

- Keep the working area orderly to ensure that extraneous objects do not become entangled when the screwdriver or other instrument being measured is operated.
- Never point the driver bit in any direction other than into the torque meter.
- If the torque meter shows any functioning abnormality, cease operation immediately and contact HIOS Corporation or your HIOS dealer.
- Operators of power tools should always button cuffs and shirt fronts and fasten zippers on apparel when conducting operations.
- Operators of power tools should not wear gloves, as this interferes dangerously with having a proper grip on the tools.

■ Precautions in operating a digital torque meter

- Never exceed the maximum torque levels indicated in the specifications on page 14. Exceeding capacity load levels by 120% will result in internal damage to the meter.
- The battery charger is for NiMH batteries only. Never use any other kind of battery, even from HIOS.

- Operating the Fidaptor
See pages 10 and 11 concerning operation of the Fidaptor.
- Do not use this instrument for measurement of continuous impact tools like air drivers or impact wrenches.*
- Do not disassemble the instrument or loosen the screws on its body, as this could cause inaccuracy in measurement.
- Use of the battery charger
See page 12 for instructions on battery charging.
- Use only the products specified in these operating instructions for connection to the data output ports.
- When disconnecting cables, grasp the cable plug and take care not to damage connector pins.
- Always turn the power switch off after completing measurement operations.
- Do not strike the acrylic display panel or place heavy objects on it.
- Avoid excessive internal adjustments for calibrating or other purposes.
- Handle the instrument with care and take care not to drop it.
- This instrument is sensitive to ambient conditions. Avoid using it in the following kinds of places:
 - Places where water, oil or other liquids could fall onto or get inside the instrument.
 - Places subject to vibration, dust or hot air.
 - Outdoors, or places where electrical discharges may occur.
 - Places of high temperature or humidity. (Operating humidity and temperature ranges for digital torque meters are 25% — 65% and 15°C — 35°C).
 - Any other place where there is a danger of the instrument being damaged or its functioning impaired.
- Please do not store the instrument in places of high temperature or high humidity. This could result in condensation forming inside, which could endanger functioning.

* HIOS offers other instruments for measurement of air drivers, impact wrenches, etc. Please contact HIOS Corporation or your HIOS dealer for information.

■ HIOS Digital Torque Meter controls

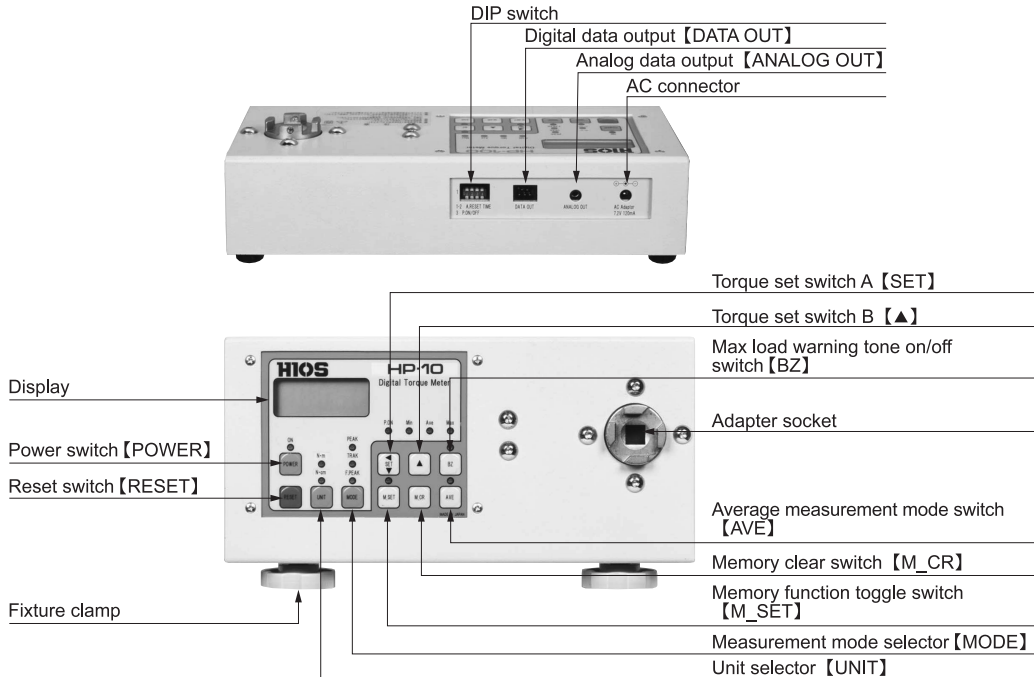







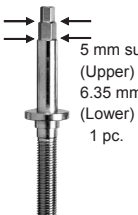

■ Functions

Control	Function																
Power switch 【POWER】	Button switch. The LED lights when the power is on. *1 The power is automatically turned off when the instrument is not operated (or torque load is less than 10) for a period of 10 minutes.																
Reset switch 【RESET】	Used to return the display to zero or print out data.																
Display	Measuring unit display <table border="1" style="margin-left: 20px;"> <thead> <tr> <th>Model</th> <th>N•m</th> <th>N•cm</th> <th>N•mm</th> </tr> </thead> <tbody> <tr> <td>HP-1</td> <td>—</td> <td>0.00</td> <td>0.0</td> </tr> <tr> <td>HP-10</td> <td>0.000</td> <td>0.0</td> <td>—</td> </tr> <tr> <td>HP-100</td> <td>0.00</td> <td>0</td> <td>—</td> </tr> </tbody> </table>	Model	N•m	N•cm	N•mm	HP-1	—	0.00	0.0	HP-10	0.000	0.0	—	HP-100	0.00	0	—
Model	N•m	N•cm	N•mm														
HP-1	—	0.00	0.0														
HP-10	0.000	0.0	—														
HP-100	0.00	0	—														
Unit selector 【UNIT】	Switches between one of the following combinations of torque measurement units, depending on which combination the purchaser ordered: N•m↔lbf•in, N•m↔N•cm, N•m↔kgf•cm																
Measuring mode selector 【MODE】	PEAK: Freezes display at peak torque value. (Press reset to cancel) TRACK: Displays current torque value. F.PEAK: Freezes display at first peak torque value.																
AC connector	For battery charger.																
Analog data output 【ANALOG OUT】	Port for analog voltage data output.																
Digital data output 【DATA OUT】	Press reset to output measurement data. This functions makes it possible to use the instrument in statistical process control systems.*2																
DIP switch	For setting auto reset timer and turning data output on ("P.ON" LED indicates "on" setting).																
Torque set switch A 【SET】	Sets maximum torque load at which warning tone will sound																
Memory function toggle switch 【M_SET】	The LED lights when the memory function is on.																
Torque set switch B 【▲】	Sets the torque level at which the warning tone sounds.																
Max load warning tone on/off switch 【BZ】	The LED lights when this function is on.																
Memory clear switch 【M_CR】	Deletes data in memory.																
Average measurement mode switch 【AVE】	When average measurement mode is on, the LED lights and the torque measurement average values are displayed.																
Adapter socket	For connecting of torque tool, using a HIOS Fidaptor or other type of adapter.																

*1 Please push the power switch and detach it immediately until a buzzersounds.

*2 Statistical Process Control (SPC) uses statistical techniques to monitor variations in manufacturing processes for use in quality control.

■ Items included with torque meter

Model	Market Areas	Supplied Accessories		Accessories for exclusive use of HP-100.	
		Fidaptor with Safety Guard	Driver Shaft		
HP-100	Korea Taiwan Hong Kong Singapore	<p>HIOS shank $\varnothing 5$</p>  <p>Measuring range: 0.5 – 3N·m (Black Spring) Part No. TF5G-Z 1 pc.</p>	<p>Hex. shank (convertible shaft)</p>  <p>5 mm subtense (Upper) 6.35 mm subtense (Lower) 1 pc.</p> <p>Part No. TF6XG-0010</p>	<p>HIOS shank $\varnothing 4$</p>  <p>1 pc.</p> <p>Part No. TF5G-0010-4</p>	<p>Grease(*)</p>  <p>Part No. TF-G3 1 pc.</p> <p>Fidaptor Buffer Spring</p>  <p>To use for measuring Lower range: 0.15 – 0.6N·m (Yellow Spring) 1 pc.</p> <p>NOTE: * "Grease" and "Fidaptor Buffer Spring" are attached to HP-100 with H5 shank model only. * Grease is to be applied on the Fidaptor with safety guard and Driver shaft appropriately.</p> <p>Exclusive Battery Charger</p> <p>Part No.: TCH-MULTI 1 pc (for AC100-240V, A plug) PSE, cUL JAPAN, U.S.A, Canada, Mexico, Taiwan, Thailand, Philippines</p> <hr/> <p>Part No.: TCH-MULTI-CN 1 pc (for AC100-240V, A plug) CCC China</p> <hr/> <p>Part No.: TCH-MULTI-CE 1 pc (for AC100-240V, A plug) CE Vietnam, Indonesia, India, Singapore, Malaysia, Korea, Hong Kong, U.K., Ireland, South America, The Middle East, Africa, Australia, New Zealand</p> <hr/> <p>Part No. TCH-EU 1 pc (for AC100-240V, C plug) CE Europe (except U.K., Ireland)</p> <p>Calibration Sheet</p>  <p>(quantity: 3)</p>
	Europe U.S.A. Canada Australia	<p>Hex. shank (Convertible shaft)</p>  <p>5 mm subtense (Upper) 6.35 mm subtense (Lower)</p> <p>Measuring range: 0.5– 3N·m (Black spring) Part No. TF6XG-Z 1 pc.</p>			
HP-10	Korea Taiwan Hong Kong Singapore	<p>HIOS shank $\varnothing 4$</p>  <p>Measuring range: 0.15 – 0.6N·m (Yellow Spring) Part No. TF4G-Z 1 pc.</p>			
	Europe U.S.A. Canada Australia	<p>Hex. shank (convertible shaft)</p>  <p>5 mm subtense (upper) 6.35 mm subtense (Lower)</p> <p>Measuring range: 0.15 – 0.6N·m (Yellow Spring) Part No. TF6SG-Z 1 pc.</p>			
HP-1	Korea Taiwan Hong Kong Singapore Europe U.S.A. Canada Australia				

- Old models of the Fidaptor and the intershank are not compatible with model HP-100.
- The main unit and accessories come all together in a dedicated aluminum attache case.
- No Fidaptor is available for HP-1. Please make test piece referring to page 12 and measure with your screw.

Note : Other battery chargers are not available.

■ Fidaptor

Fidaptor with safety cover

The Fidaptor is included with the torque meter. Connects clutch-type power screwdrivers to the torque meter socket, for measurement of torque

at the point where the clutch disengages. Features a safety cover and a mechanism that has almost the same effect as that obtained in actual tapping screw fastening work.

Limit Line on the Fidaptor TFG series

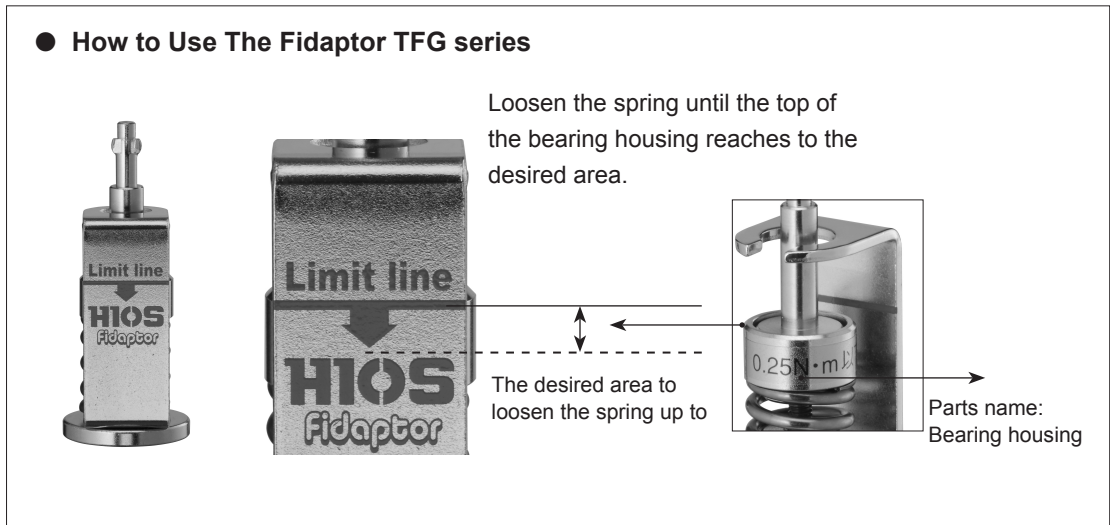

● **Note (to keep accuracy of torque measurement)**

- Loosen the spring up to the desired area for storing the Fidaptor properly.
- Scratch or wipe with chemicals such as benzoin or alcohol could cause the serigraphed "Limited line" peel-off.
- We recommend to follow the guide written in the " maintenance and inspection of the Fidaptor " in the operation manual and replace the Fidaptor driver shaft with a new one after 2,500 strokes.

● **Threaded shaft (comes with Model HP-100)**

Use as adapter for bits that are not the 5 mm HIOS standard diameter. (Refer to diagram on page 10 when changing shock absorber spring.)

■ Operating instructions

First check the state of the battery charge. When the power is on and the battery has an insufficient charge, the display reads "LOBAT." When this happens, use the battery charger to recharge the battery for at least 3 hours and no more than 6 hours.

1. Make sure the digital torque meter is stable.
2. Select the unit of measurement desired [UNIT] switch). (N•m↔N•cm) (N•m↔lbf•in) (N•m↔kgf•cm) (N•cm↔N•mm, only for HP-1)
3. Conduct zero adjustment. Set [MODE] switch to "TRACK", then press both the [SET] and [▲] switches at the same time for less than 2 seconds. This adjusts the meter to zero. (Note: If you press the switches for than 2 seconds, the meter will go into another mode. If this happens, press [RESET] , then repeat the zero adjustment process.)
4. Set [MODE] switch to "PEAK" or "F.PEAK".
 - In peak mode the peak torque value reached during measurement is displayed. Thus, the display does not change. Model HP-100 measures up to 10 N•m of torque, which corresponds to a display value of 15. Please conduct measurements within this range.
 - In "F.PEAK" mode the first peak value is displayed and does not change even if higher torque is applied.
5. Press the [RESET] switch to cancel the display.
6. Minus signs appear in front of measurements of counterclockwise torque.
7. To output data using a Mitutoyo Input Tool, set the No. 3 connector of the DIP switch (page 8) to the on position (so the "P.ON" LED lights), set the [MODE] switch to "PEAK" and press the [RESET] switch (which functions the same as the Enter key on a computer) . The Input Tool will convert the measurement data for direct input to a spreadsheet application. In order to output data, please conduct measurement within the instrument's peak measurement range, as indicated in the specifications.
 - Minus signs denoting counterclockwise torque are transferred with the measurement data.
8. Use the Fidaptor to measure torque of power screwdrivers, as explained below.
9. It is possible to fashion adapters for torque measurement of other types of tools. (See "Using

the adapter socket for torque measurement of instruments other than screwdrivers.")

10. Be sure to turn off the power and remove the tool from the socket when you are finished measuring.

■ How to measure screwdriver torque using the Fidaptor

1. Insert the Fidaptor into the digital torque meter's socket, then fit the bit of the screwdriver to be measured into the head of the Fidaptor. The Fidaptor is for bits of 5 mm. Model HP-100 comes with two threaded shafts in addition to the Fidaptor that can be used for three different bit diameters. (Refer to diagram on page 10 when changing shock absorber spring.)
2. Take some tension off the Fidaptor's spring by running the screwdriver in reverse "REV", so that spring can be turned slightly by hand.
3. Press the reset switch to return the display to zero.
4. Run the driver in the forward direction "FOR" until it stops automatically. The Fidaptor spring will tighten.
5. When the driver stops the display will show the output torque of the driver.
6. Release the tension on the spring by running the driver in the reverse "REV" direction, then press the reset switch to cancel the display.
7. Repeat the above procedure to confirm the output torque value. Refer to the output torque guide table in the operating instructions for your HIOS power screwdriver to set the torque adjustment nut to an appropriate torque value.

■ Explanations of functions

DIP switch

Always turn off the power before changing DIP switch settings.

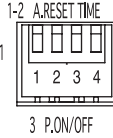

- Auto-reset

DIP switch settings

Switch number		A.RESET TIME		P.ON/OFF	
		1	2	3	4
Time to auto-reset ¹	1 sec	ON	ON	—	—
	2 sec	ON	OFF	—	—
	5 sec	OFF	ON	—	—
	OFF	OFF	OFF	—	—
Data output	Printer ON ²	—	—	ON	—
	Printer OFF	—	—	OFF	—

Notes

- ¹ The reset switch does not function when auto-reset is on.
- ² The error display (see below) appears when a printer or the Mitutoyo Input Tool is connected for data output and the LED lights.

Error display



- Data output

1. Set the mode switch to "PEAK" or "F.PEAK".
2. Set data output DIP switch number 3 to the on position.
3. Connect a printer or the Mitutoyo Input Tool to the Digital data output port. (Pressing the reset switch in this state will result in the error display. An error will also result if you try to print out data with a printer that cannot print out numerical data containing decimal points.)
4. Conduct measurement, then press the reset switch to output the data. Average [AVE] values cannot be output.

Output of data from the memory (memory function on)

Note: Please cancel auto-reset.

1. Press the reset button for 2 seconds.
2. When the display shows the letters "Prn," press reset. 
3. All the torque data, from memory number 0001, will be output. The display flickers during data transfer.

Setting torque

The digital torque meter is shipped with the warning tone set to sound when maximum torque load is reached. This tone also sounds when the torque set-

ting has been changed. The torque setting can be changed as desired. The warning tone signals that the set torque value has been measured.

Example (torque set at 100)

Data is output only for measurements up 100.

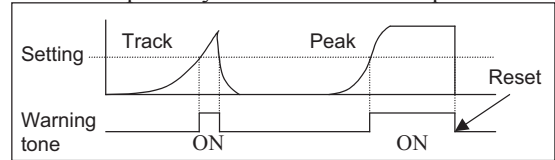

Switch functions for setting torque

Switches used

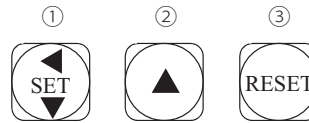

① [SET] switch

1. Press for 2 seconds to enter torque setting mode. Press for 2 seconds once again to exit torque setting mode.
2. When the meter is in torque setting mode, the 4-digit display can be adjusted, one digit at a time. Use the SET switch to select the digit for adjustment. The selected digit blinks on and off. Each time the SET switch is pressed, the next digit to the left is selected (or, if pressed while the leftmost digit is selected, the rightmost digit will be selected.)

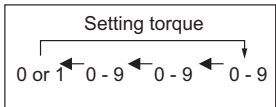

② [▲] switch

- When the meter is in torque setting mode, this switch increases the selected number by one each time it is pressed. Note that the leftmost digit can only be 0 or 1.

③ [RESET] switch

- Pressing this switch readies the meter to begin measurement. Pressing it while in torque setting mode cancels the process and takes the meter out of torque setting mode.

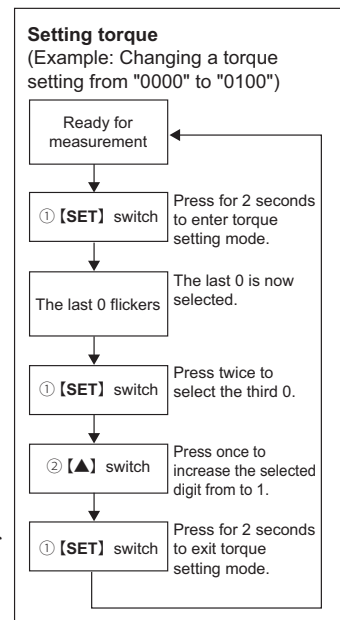

Memory

Objective

Measurement data can be stored in the memory for management of everyday operations.

Storing and reading out measurement data

1. The memory can store 100 measurements. The measurements are numbered automatically, from 0001 to 0100. If data from previous measurements remains in the memory, the new measurements begin from the next available number. (Fig. 1)
2. Fig. 2 shows how to display data stored in the memory.
3. When the 100th result has been stored in the memory, delete some of the data (Fig. 3) or all of the data (Fig. 4) to make room for the next series of measurements.

Memory full display



The flickering display "FUL" appears when the memory is full. To clear this display, press [RESET].

Switch functions in memory mode

Switches used

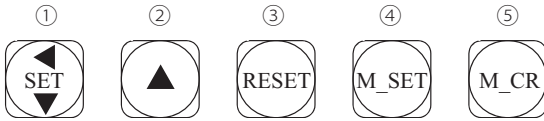

- ① [SET] switch
When the memory function is on, pressing this switch displays the last measurement in the memory.
- ② [▲] switch
When the memory function is on, pressing this switch displays the first measurement in the memory.
- ③ [RESET] switch
When the memory function is on, pressing this switch returns the instrument to a state of readiness to begin recording data again. Press to end recording, to display or to delete data.
- ④ [M_SET] switch
Press for 2 seconds to enter or exit measuring mode. The LED lights when measuring mode is on.
- ⑤ [M_CR] switch
Pressing this switch deletes memory contents.

Note that data can be output (see "Data Output" on page 8) whether or not the LED is on.

Fig. 1 Recording readout

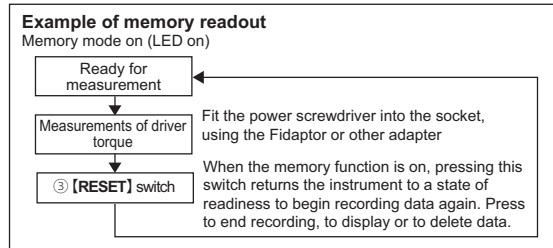

Fig. 2 Displaying recorded data

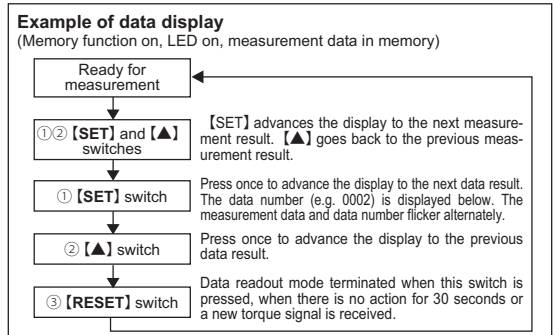
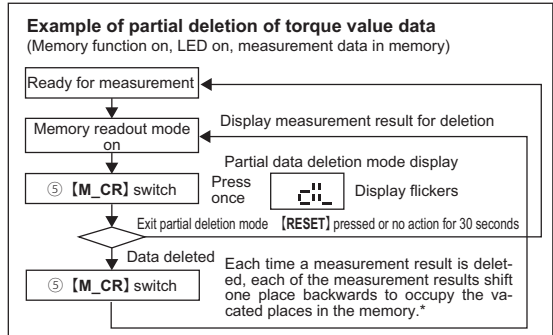

Fig. 3 Partial deletion of measurement data



* Partial deletion of measurement results

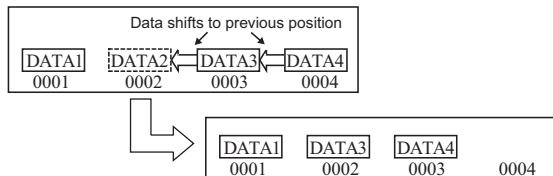
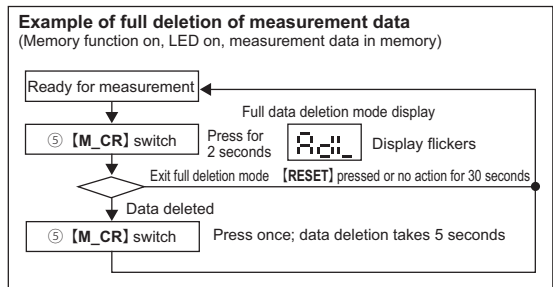

Fig. 4 Full deletion of measurement data



Measurement of average torque

Objective

Simple monitoring of torque for normal operations

Measurement procedure

Makes possible measurement of the minimum, average and maximum values among sets of measurements, each set consisting of up to ten measurements.

1. The measurement results are automatically numbered, from 0001 to 0010. Negative displays are not recorded. Measurements in average mode are automatically deleted when the meter exits average mode.
2. If less than 10 measurements are made, the display shows only those measurements.

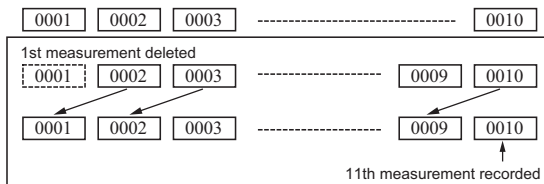

Switch functions in average measurement mode

Switches used

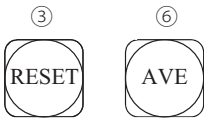

③ [RESET] switch

Puts the instrument into a state of readiness to begin measurement when in average measurement mode. Press to end measurement or display of measurement sets.

⑥ [AVE] switch

Press for 2 seconds to enter or exit average measurement mode. The LED lights when in average measurement mode. The figure show the average measurement and display cycles.

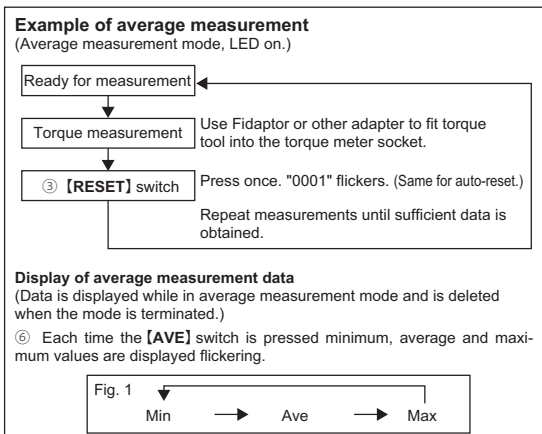

Notes

1. Be sure to set [MODE] switch to "PEAK" or "F.PEAK" before entering average measurement mode.
2. The [UNIT] switch does not function in average measurement mode.

■ Changing the Fidaptor's shock-absorbing spring (Model HP-100)

Two springs are supplied with Model HP-100. The black spring is high-tension and the yellow spring is low-tension. The 5 mm Fidaptor is shipped with the black spring attached. For low-torque measurement, replace with the yellow spring.

- Fit the driver bit into the head of the Fidaptor. Turn the driver on in the reverse direction to loosen the threaded shaft and change the springs.

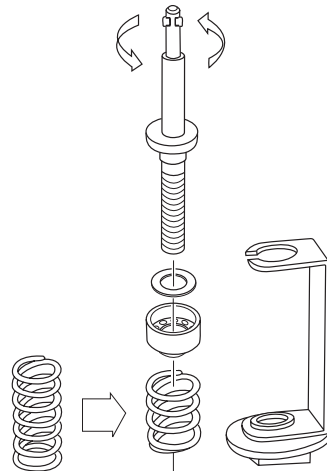

■ Care of the Fidaptor

Please read carefully the following points about handling the Fidaptor.

• Using the Fidaptor

1. Never place a load on the Fidaptor that exceeds the indicated measurement capacity.
2. Use the Fidaptor that is designed for the torque level of the tool to be measured.
3. Keep the Fidaptor loose, and after measurement remove it from the socket.
4. Keep the driver and Fidaptor upright during measurement. Keep torque from the upper surface to within 5 kg, or 2 kg, in the case of a low-torque Fidaptor.
5. When conducting a series of measurements, apply grease* to parts ①, ② and ⑤ of the Fidaptor, as shown in the figure on page 11.

6. See that each measuring cycle lasts 5 seconds or more to minimize wearing of parts.
 7. Never attach the Fidaptor unless you intend to use it immediately. When it is not in use, always remove it from the torque tool and remove the tension from the spring.
 8. Always be sure that the Fidaptor is properly attached to the torsion tool.
 9. Do not use the Fidaptor if it has been bent or in some way modified.
- *Use the grease supplied with the torque meter to apply to parts as necessary. This grease can be purchased separately (part number TF-G3).

- **Maintenance and inspection of the Fidaptor**
 1. Apply the grease periodically to parts ①, ② and ⑤ in the figure below.
 2. Always inspect the parts of the Fidaptor before use.
 - (1) Is there grease on parts ①, ② and ⑤?
 - (2) Have the threads of the threaded shaft become worn?
 - (3) Is there dirt or foreign material on the threaded shaft?
 3. The Fidaptor must eventually be replaced. **It should be periodically inspected and replaced when necessary.**

■ Fidaptor parts

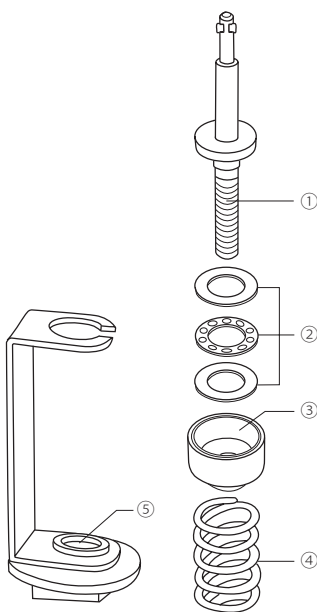

Name of part	Type	Part number	
① Threaded shaft	HP-100	HIOS 4 mm	TF5G-0010-4
		HIOS 5 mm	TF5G-0010
		Hex shank (fits 5 mm and 6.35 mm sockets)	TF6XG-0010
	HP-10	HIOS 4 mm	TF4G-0010
② Bearing set	HP-100	TF5-0020	
	HP-10	CL65-0250	
③ Bearing housing	HP-100	TF5G-0030	
	HP-10	TF4-0030	
④ Spring	Black spring (0.5 - 3N•m)	TF5-0051	
	Yellow spring (0.15 - 0.6N•m)	CL65-0040	
⑤ Plate nut	HP-100	TF5G-0050	
	HP-10	TF4G-0050	

Guide to when it's time to replace Fidaptor parts

- ①, ② : Threaded shaft and bearing set: After 2,500 strokes
- ① : Threaded shaft only: When it becomes bent or its threads are worn
- ④ : Spring: Replace together with threaded shaft after 2,500 strokes
- ⑤ : Plate nut: After 5,000 strokes



Note

The safety cover provides protection against the possibility of shaft breakage due to wearing or metal fatigue, but for an added measure of safety it is recommended that the user follow the above guide to parts replacement.

Other parts (available for separate purchase)

Item	Driver Shaft	Measuring Range	Part No.	Note
Fidaptor	Hex. shank 6.35 mm subtense	3 - 9N•m	TF6U-Z ¹	For HIOS torque drivers with lever-start.
Fidaptor	Hex. shank 6.35 mm subtense	3 - 9N•m	TF6UP-Z ²	For HIOS CL-9000 or high torque derives with both lever-start and push-to-start.
Standard accessory set for HP-100			TF5G-SET	See the Manual p.4 of Standard accessories (without battery charger).

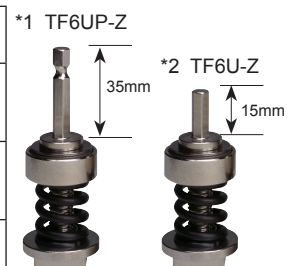

■ Use of the socket

In addition to the Fidaptor or threaded shaft, it is possible to make one's own adapter to fit torsion tool bits of different diameters into the socket for measurement. Keep the following points in mind when fashioning such an adapter.

Details of the socket

HP-10 • P-100

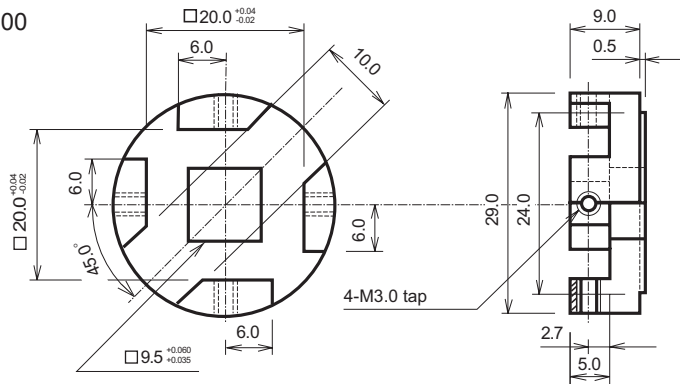

HP-1

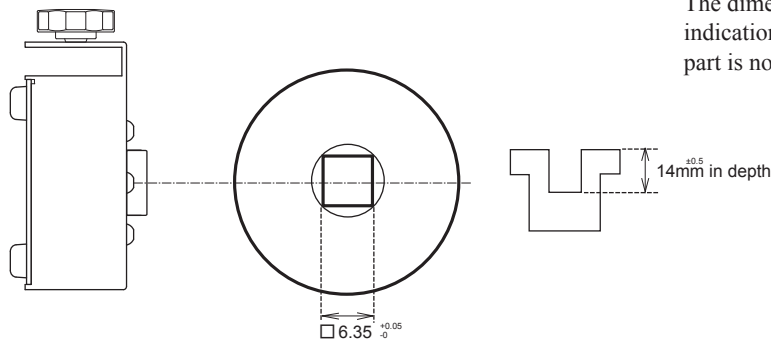

Attention

The dimensions indication of the socket part is not to scale.

Cautions in making a socket adapter

- Make sure that the adapter fits snugly into the socket.
- Make sure the adapter is strong enough that it won't break during measurement.
- Do not attempt to use an adapter that delivers more than 10 kg of vertical torque.
- Do not use this torque meter to measure impact torque tools.
- Take care to observe all other principles of torque measurement.

■ Battery charger

To charge batteries for the HIOS torque meter use only the battery charger provided with the meter. Always turn the power off when charging. The first time will require 6 hours for a full charge.



Caution

- Do not recharge the battery for longer than 6 hours.
- Use only NiMH batteries, never any other kind, even if obtained from HIOS Corporation.
- Do not use the meter while charging the battery.
- When the letters "LOBAT" appear in the display, stop measurement and recharge the battery.

- Do not use the battery charger for any purpose other than charging batteries for this instrument.
- Do not place objects on top of the battery charger's cord. Do not subject the cord to extreme bending or tie it in knots.
- Be sure the power to the instrument is off when attaching or detaching the battery charger.
- Do not attempt to remove the battery from the instrument.



Danger!

- Leaving the battery charger on for the maximum recharge time of 6 hours could lead to overheating, damage to the instrument or fires.

■ How to recharge

1. Turn off the power to the torque meter and insert the battery charger cord into a power source.
2. When recharging is complete, unplug the cord, turn the torque meter power switch on and check that the display goes on.
3. Wait for the battery charger to cool, and store it in an appropriate location.

■ Types of data output

Use the Mitutoyo Input Tool (available for purchase from many dealers) to transfer measurement data to a computer.

- USB keyboard conversion type, P/N: IT016U
* Input tool cannot be used for some PCs. For details, please contact Mitutoyo Corporation.
Connection cable NO.06AGF590 2m (sold separately)

(Please contact Mitutoyo Corporation or a Mitutoyo dealer about purchasing these items.)

■ Types of analog data output

An analog cord is available for separate purchase (1.5 m, item HP-8060). This cable can be used to connect a pen recorder, oscilloscope or voltmeter to the HIOS torque meter. When using these instruments, read their operation manuals to insure correct operation.

■ Customer service

- Repair
1. Service charges will be made for repairs under the following circumstances:
 - (1) Malfunctioning or damage caused by incorrect use of the instrument, the instrument has been disassembled or it malfunctions due to attempted repair.
 - (2) Oil has been added to the socket, switches or inside the instrument.
 - (3) The instrument has been damaged during shipping, by dropping, etc.
 - (4) Damage due to fire, exposure to gas, earthquake, water, irregular power supply or other type of disaster.
 - (5) Service charges will also be made for calibration, inspection or parts replacement for the Fidaptor, etc.
 2. No charge will be made for service in the case of inspection and/ or calibration of the same part that becomes necessary within three months af-

ter inspection or calibration has been performed. (This does not apply under circumstances (1) – (4) above.)

- Shipping and handling charges incurred for repair service must be paid by the customer. Please direct questions about customer services to HIOS Corporation or your HIOS dealer.

■ Attention

The product that you have purchased contains a rechargeable battery. The battery is recyclable. At the end of its useful life, under various state and local laws, it may be illegal to dispose of this battery into the municipal waste stream. Check with your local solid waste officials for details in your area for recycling options or proper disposal.



Ni-MH

■ Inspections and calibration

HIOS torque meters employ a unique sensor mechanism that maintains accuracy for long periods. A tool for checking its accuracy (the HIOS calibration check bar) is provided, but in addition to this, we recommend that the torque meter be sent in to HIOS Corporation for inspection at least once a year. (Note that a fee is charged for this service.)

HIOS torque meters are shipped calibrated to meet our accuracy standards. Depending on the conditions under which the meter is used, accuracy may be affected over the course of months or years. Therefore, HIOS offers calibration and, when necessary, overhaul services. We also recommend use of the periodic calibration documentation included with the torque meter. This documentation shows the relation of the HIOS standards to Japan's standards.

■ Cautions to be observed when sending the torque meter in for calibration or repair

1. Pack the meter in the attache case in which it was originally shipped to protect it from violent impacts during shipping.
2. Do not put anything into the attache case other than the items originally shipped inside. Never include items such as homemade mounting plates, tools or extra bits. HIOS cannot assume responsibility for these.
3. Please explain the nature of the difficulty with the instrument in sufficient detail.

■ Troubleshooting

Before you conclude the torque meter is broken, go through the following troubleshooting guide. If, by following the instructions, you are unable to resolve the difficulty, please contact HIOS Corporation or your HIOS dealer.

Problem	Causes	Resolving the problem
The display says "LOBAT"	<ul style="list-style-type: none"> Insufficient battery charge 	<ul style="list-style-type: none"> Recharge the battery as explained on page 12. If this does not resolve the problem, contact HIOS or your HIOS dealer.
There is no display	<ul style="list-style-type: none"> This may be due to long-term use of the meter or natural battery discharge over time. 	<ul style="list-style-type: none"> Turn the power switch off, conduct a full battery recharge (6 hours, no more), then turn the power switch on and see if there is a display. If there is not, contact HIOS or your HIOS dealer.
The displayed value does not return to zero	<ul style="list-style-type: none"> Unable to conduct zero adjustment. 	<ul style="list-style-type: none"> Conduct zero adjustment.
The displayed values do not stop changing	<ul style="list-style-type: none"> The [MODE] switch is set to "TRACK" 	<ul style="list-style-type: none"> Set to "PEAK."
Unable to recharge the battery	<ul style="list-style-type: none"> The battery charger plug may not be engaged all the way into its socket. 	<ul style="list-style-type: none"> Check that the plug is connected properly.
	<ul style="list-style-type: none"> The connection may be to the wrong terminal. 	<ul style="list-style-type: none"> Connect to the battery charger socket. If the above does not remedy the problem, contact HIOS or your HIOS dealer.
The "LOBAT" display reappears after battery recharging is complete	<ul style="list-style-type: none"> The battery may have reached the end of its operational life. 	<ul style="list-style-type: none"> Send to HIOS for repair.
	<ul style="list-style-type: none"> The battery charge may be insufficient. 	<ul style="list-style-type: none"> Recharge the battery for no more than 6 hours.
The display shows a numerical value when it shouldn't	<ul style="list-style-type: none"> This may be due to noise occurring from the power source, etc. 	<ul style="list-style-type: none"> Press [RESET] switch to clear the display.

■ Specifications

Model		HP-1	HP-10	HP-100
Peak range	N•m	/	0.015 - 1.000	0.15 - 10.00
	N•cm	0.15 - 10.00	1.5 - 100.0	15 - 1000
	N•mm	1.5 - 100.0	/	/
	lbf•in	0.015 - 0.90	0.15 - 9.00	1.5 - 90.0
	(kgf•cm)	/	(0.15 - 10.00)	(1.5 - 100.0)
Accuracy*	within $\pm 0.5\%$ (at full scale)			
Power	five 1.2 V NiMH cells 1,000 mA			
Recharge time	up to 6 hours			
Running time on full charge (continuous operation)	8 hours			
Battery life	About 300 chargings			
Dimensions	See figure			
Weight	1.8 kg			
Battery charger	Runs on 100-240 V AC power (50 or 60 Hz) Output 7.3 - 8 V DC (0.5 A)			

- Never exceed the maximum torque tolerance level for the instrument.
- Because battery life depends on operating conditions, this cannot be guaranteed.

External features diagram

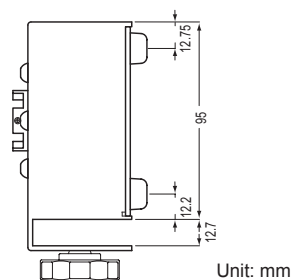
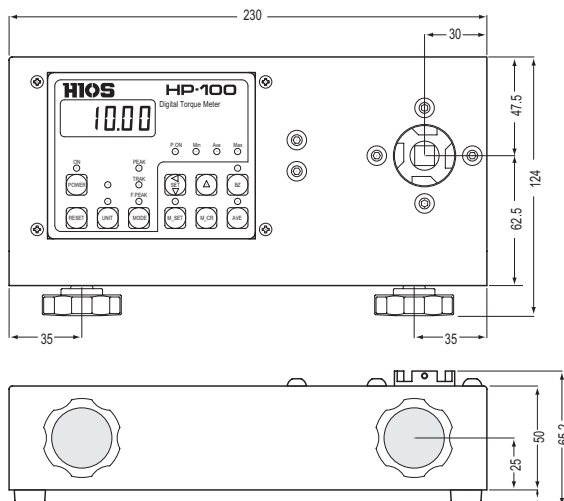

- As for the dimensions, HP-1, 10 and 100 are the same.

Note that specifications or the external appearance of HIOS torque meters are subject to change without notice.

Analog and data output specifications

A display of 1000 means approximately 1 volt.

Serial data output specifications

1. Pin assignments

Mitutoyo MQ65-5P

- ① GND: Ground
- ② DATA: Outputs data in the format indicated below.
- ③ CK: Clock
- ④ RD: Demands data reception

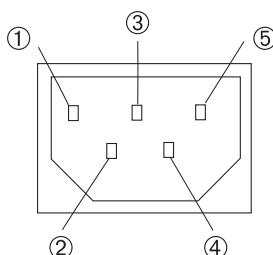

- ⑤ REQ: Demands data output from external source
- ① - ④ : Open drain
-0.3 – +7 V (400 μ A max.)
- ⑤ : Pull up to V_{DD} (1.55 V)

2. Data output format

Following is an explanation of the meanings of the 13-digit data output from the torque meter.

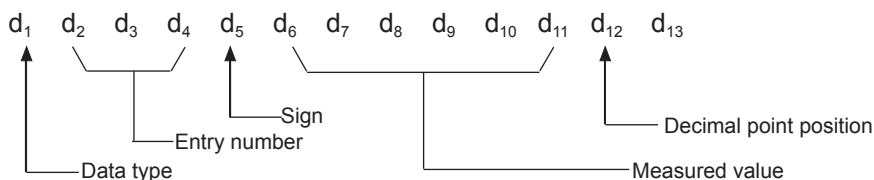

Each digit is output in four-bit binary notation from the least significant bit in the sequence $2^0 \rightarrow 2^1 \rightarrow 2^2 \rightarrow 2^3$.

3. Timing chart

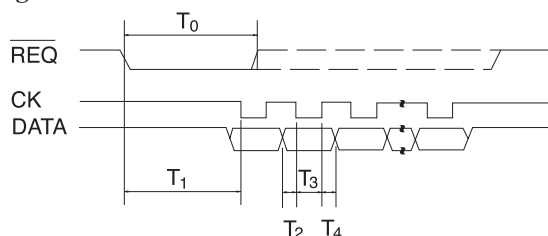

	MIN	MAX	UNIT
T_0	2	—	sec
T_1	0.2	0.4	sec
T_2	0.2	0.4	mS
T_3	0.5	1	mS
T_4	0.2	0.4	mS

■ China RoHS2 Table

If you are asked by China Customs, please show this table to them.

有害物质名称及含量标识格式						
产品中有害物质的名称及含量						
部件名称	有害物质					
	铅(pb)	汞(Hg)	镉(Cd)	六价铬 (CR(VI))	多溴联苯 (PBB)	多溴二苯醚 (PBDE)
电路板总成	×	○	○	○	○	○
外壳	○	○	○	○	○	○
充电电池	×	○	○	○	○	○
电源适配器	×	○	○	○	○	○
-						
-						
-						
-						

本表格依据 SJ/T 11364 的规定编制。
 ○：表示该有害物质在该部件所有均质材料中的含量均在 GB/T 26572 规定的限量要求以下。
 ×：表示该有害物质至少在该部件的某一均质材料中的含量超出 GB/T 26572 规定的限量要求。

In addition, the China RoHS marks also is required at the product and product box.

At the product, you can find it at the bottom and it is marked on the product box.

If you cannot find the mark, please ask your distributor.

In case of emergency, please cut the mark below and stick at the bottom of product and on the product box.

China RoHS mark

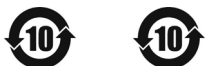

Note: minimum size of China RoHS mark is 5mm at outer diameter



HIOS Inc.

1-35-1 Oshiage, Sumida-ku Tokyo, Japan 131-0045

TEL: 81 (Japan) 3-6661-8821 FAX: 81 (Japan) 3-6661-8828

www.hios.com