



Power Supply for Automatic Brushless Screwdriver

# BLT-AY-61 / BLT-AY-71

## Instruction Manual

(July 2018)



Table of Contents

**03 Safety Instructions**

**04 What Can Be Done with This Unit:**

**05 Parts and Their Functions**

Front

Rear

Configuration of I/O Circuit

Inside the Cover

Switching Between Reading Start and Pulse Start

**09 Change the Operational Settings of the Automatic Screwdriver**

Basic Setting Procedure

List of Setting Items and Setting Values

**12 Relation Between the Rotation Number and Torque of the Automatic Screwdriver**

BLF-2000/BLF-5000

BLF-7000/BLF-7000X/BLF-7025X

PGF-3000/PGF-5000/PGF-7000

**15 Torque Up Settings**

Clutch Mechanism

**17 Timing Chart Table**

**36 Specifications**

External Dimensions

**38 Terminology Related to This Unit**

**39 China RoHS2 Table**

## Safety Instructions

Please read this instruction manual carefully before use to ensure proper operations.

### Installation

- Do not install this unit in a place with a lot of dust, dirt, metal pieces, etc.
- Use this unit in the operating environment of temperatures between 5 to 40 °C and humidity of 80% or less (no dew condensation).
- Do not place heavy objects on top of this unit or stack them.
- Choose a stable location with no vibrations. Especially, when installing this unit in a high place, fix it firmly.
- Do not install this unit near high-voltage equipment or in a noisy environment.

### Handling

- On any commercial power supply, be sure to install an earth leakage breaker and a safety breaker.
- Connect the earth wire and use this unit with the specified rated voltage.
- The load connected to the output terminal on the back should not exceed the rated load. Exceeding the rated load may cause a malfunction.
- If external devices connected to the I/O ports on the back are affected by the electromagnetic induction load from the relay, solenoid valve coil or others, take measures against noises by using a diode to absorb reverse voltage. Otherwise, it may cause a malfunction and failure.
- When the automatic screwdriver is locked or overloaded, the overload protection works. Please note that if the overload protection works frequently, that operation may impose a load larger than the capability of this unit or the automatic screwdriver.
- Even if it is properly used, if the overload protection works frequently with abnormal events including heat-up, immediately stop using it, turn off the power, unplug the power cord, and send it to our service department for repair.
- When you tighten screws of workpieces such as resin products that are charged with a lot of static electricity, discharge them before screw tightening. If the workpieces are not completely discharged, static electricity may flow into the unit from the tip of the bit causing malfunctions.
- When external equipment is to be used with an external power supply using the function of this unit, use the GND as the common terminal.

- Failure to do so may cause a malfunction and failure.
- Do not apply a voltage to the input side. It may cause a malfunction.
- Do not make the wiring for input / output longer than necessary.
- Note that bundling power cables together may cause a malfunction.
- Do not connect parts other than specified ones to the connection part of this unit. It may cause a malfunction.
- Do not disassemble or remodel this unit. It may cause a malfunction.
- In that case, we may not be able to accept your claim for warranty or repair.
- Do not cause any strong impacts or vibrations against this unit.
- Do not drag cords and do not allow them to touch oil or sharp edges, or to be trapped under heavy objects.
- When connecting/disconnecting the power cord or screwdriver cord, always hold the plug.
- If it is not used for a long time, turn off the power and disconnect the power plug from the outlet for safety.

### Illustrations

- Illustrations used in this manual are those for BLT-AY-61 unless otherwise specified. However, if models have differences, multiple illustrations are also displayed with the model names such as "BLT-AY-61 / BLT-AY-71."

## What Can Be Done with This Unit:

- Rotation speed can be switched between high and low, and each speed has 11 steps.
- The forward and reverse rotations as well as high speed and low speed rotations of the automatic screwdriver can be externally controlled.
- The FOR input for forward rotation can be switched between pulse/reading (for details, see P.08).
- Tightening check (impact number) can be set, and torque-up trigger in forward or reverse rotation can be selected.



### Note:

**Torque-up for reverse rotation is not available for a standard automatic screwdriver because the one-way clutch works.**

- For tightening reverse screws, a special automatic screwdriver for reserve screws is required.
  - A special automatic screwdriver for reverse screws is available as an option. Please contact our distributor.
  - When using the forward rotation screwdriver for reverse rotation, set the reverse torque-up to U0 or d0 (for example, when engaging a screw with the bit).
- The mode of the signal input can be selected in coordination with the movement of the cam movement when torque-up is set. Also, torque-up for reverse rotation can be set (in the case where the screwdriver for reverse screw is used).  
Example 1: set to U1 (torque-up trigger: once) to tighten a screw at high speed with one impact  
Example 2: set to d3 (torque-down trigger: 3 times) to tighten a screw at low speed with three impacts
  - Overtime protection  
This is to protect this unit and the automatic screwdriver. Even if the screwdriver happens to keep rotating, it can stop automatically, and the buzzer notifies it when the overtime protection is set on the controller.
  - Overload protection  
This is to protect this unit and the automatic screwdriver. If the screwdriver happens to receive overload, it can stop automatically and the buzzer or the display notifies it.



### Note:

If the overload protection works frequently, that operation may impose a load that exceeds the capability of this unit or the automatic screwdriver.

- The built-in buzzer can be switched off. (For details, see P.08.).
- The terminal block on the rear panel is detachable, and it is easy to install or replace it.



### Note:

- BLT-AY61 is only for BLF-2000/BLF-5000 and PGF-3000/PGF-5000.
- BLT-AY71 is only for the BLF-7000 series and PGF-7000.
- Please do not connect the screwdriver to any power source other than specified one. Otherwise, it may cause a malfunction or a problem.

## Parts and Their Functions

The functions on the front and rear are displayed commonly on BLT-AY-61 and BLT-AY-71.

### ■ Front

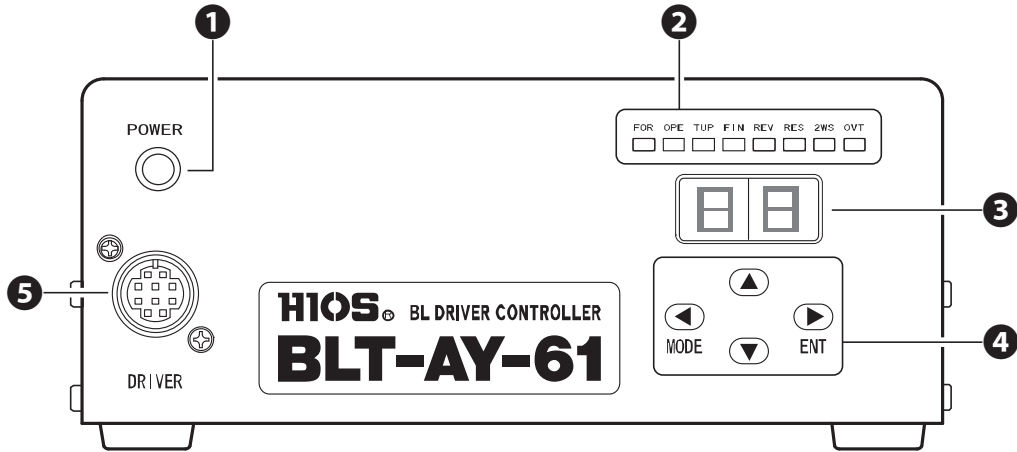

#### ① Power indicator

Lights up when the machine is power ON.

#### ② Operation display LED

The external I/O and the operational conditions of the screwdriver can be checked by looking at LEDs' on/off.

#### ③ Setting value display 7-segment

The number of torque-ups and the set rotation speed for the automatic screwdriver are displayed.

#### What does OL mean?



This is displayed when the overload protection works.

To release this, turn off the power of this unit and wait for one minute before turning it on again.

#### ⚠ Note:

If the overload protection works frequently, that operation may have been imposing a load that exceeds the capabilities of this unit or the automatic screwdriver.

#### Cases of overload

- The screwdriver is misaligned to the screw hole
- No device (such as a damper) to alleviate the shock to the screwdriver is attached
- The interval of screw tightening is too short
- In case of screws with hexagonal socket holes or screws with hexalobular socket holes; they are likely to be obliquely tightened
- In case of tightening a tapping screw with a long neck on a sticky material such as resin material

#### ④ ◀ MODE button/ ▲ UP button/ ▼ DOWN button/ ▶ ENT button

The operational settings and the related values for the automatic screwdriver can be changed. For details, see P.09.

#### ⑤ Connector for the brushless screwdriver

The screwdriver cord is connected here.

## ■Rear

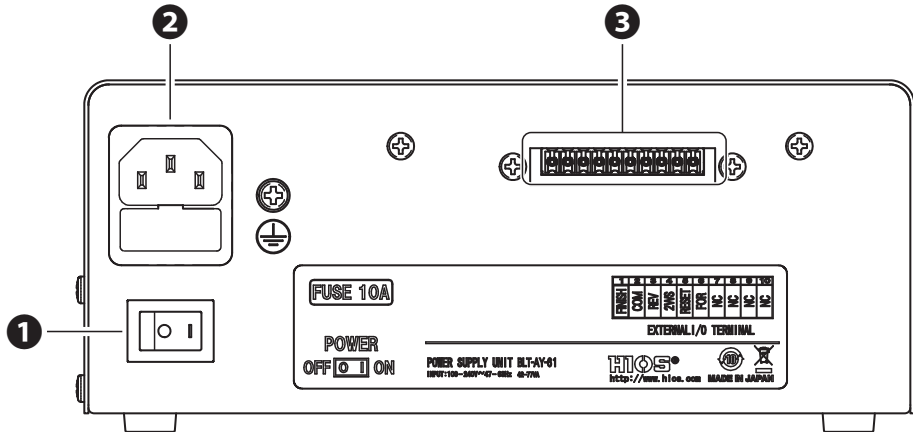

### ① Main SW

This switch turns power on and off. When turning on, the switch lamp is lit and the operation display LED and the setting value display segment are lit for about 1 second.

### ② Inlet with a fuse holder

Connect the power cord here.

### ③ External I/O terminals/terminal block connector on the main unit side

Connect the terminal block connector here. The forward and reverse rotations as well as high speed and low speed rotations of the automatic screwdriver can be externally controlled.

No.	I/O	Signal name	Description
1	External output	FINISH output	The signal is output when screw tightening is completed. It is canceled when next FOR or REV input comes in or when there is a RESET input.
2	Common	COM	The signal is common for input and output.
3	External input	REV input	The signal is input to make the screwdriver rotate reversely. Reverse rotation continues as long as there is input.
4	External input	2WS input	The rotation speed of the automatic screwdriver can be switched between two steps. The speed is LOW as long as there is input.
5	External input	RESET input	This is used to stop the automatic screwdriver.
6	External input	FOR input	<p>This is used to rotate the screwdriver forward. The start type can be selected either pulse start or reading start. The switching from one type to another can be done using the DIP SW built in the board (SW6-2). (For details, see P.08.)</p> <p>● <b>Pulse input</b> The forward rotation starts when a pulse (100mS or larger) is entered as FOR input. To stop the rotation, enter a RESET input.</p> <p>● <b>Reading input</b> The forward rotation continues as long as there is a FOR input. To stop the rotation, either turn off FOR input or enter a RESET input.</p>

## Configuration of I/O Circuit

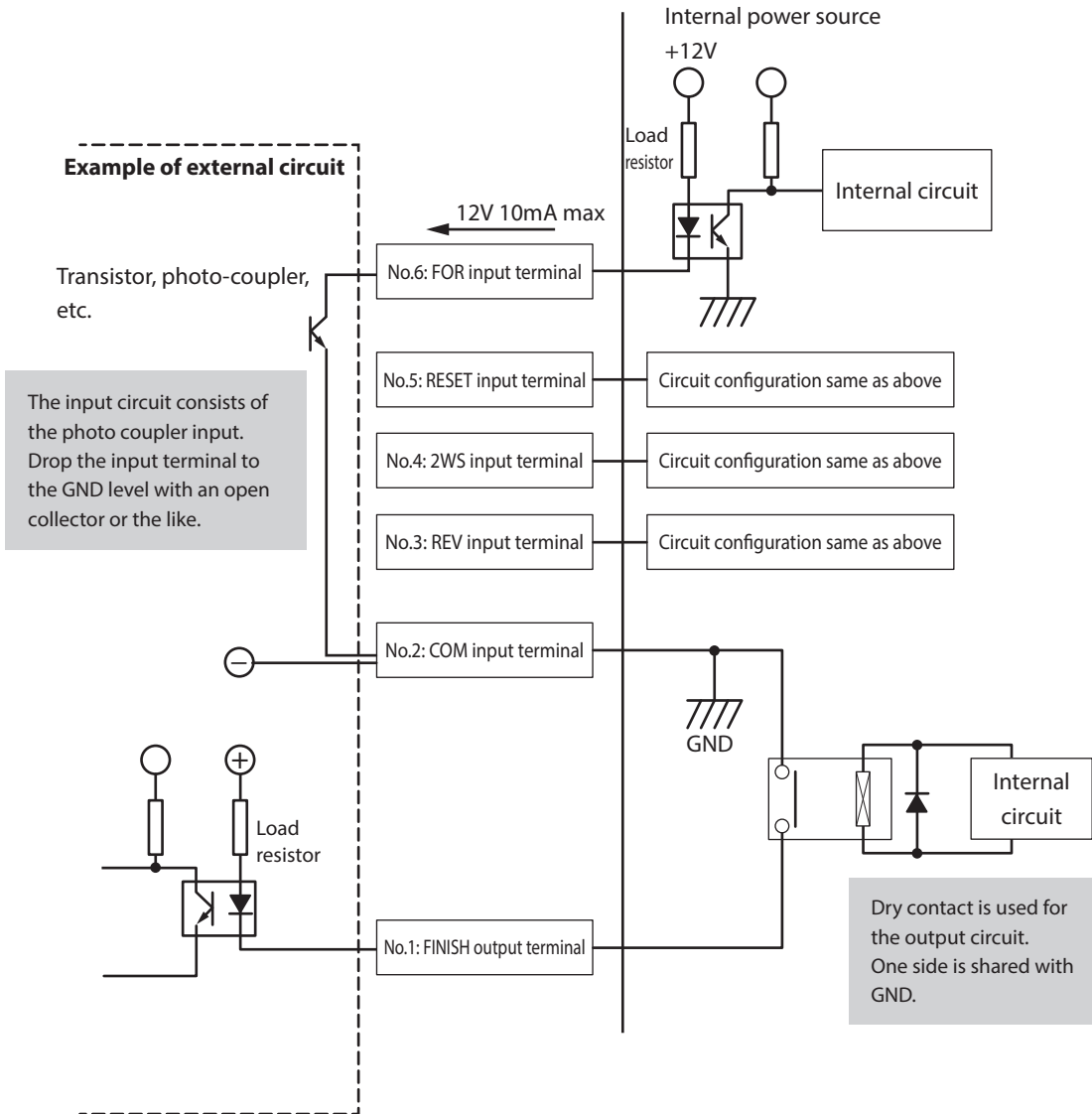

When importing the output, do so within the specified range. (Maximum DC 24V 500mA. Be careful not to exceed this maximum value due to a counter-electromotive force especially when connecting inductive devices such as a relay. Also, for both input and output, make the wiring to the connected device as short as possible and take measures against noises.)

## ■ Inside the Cover

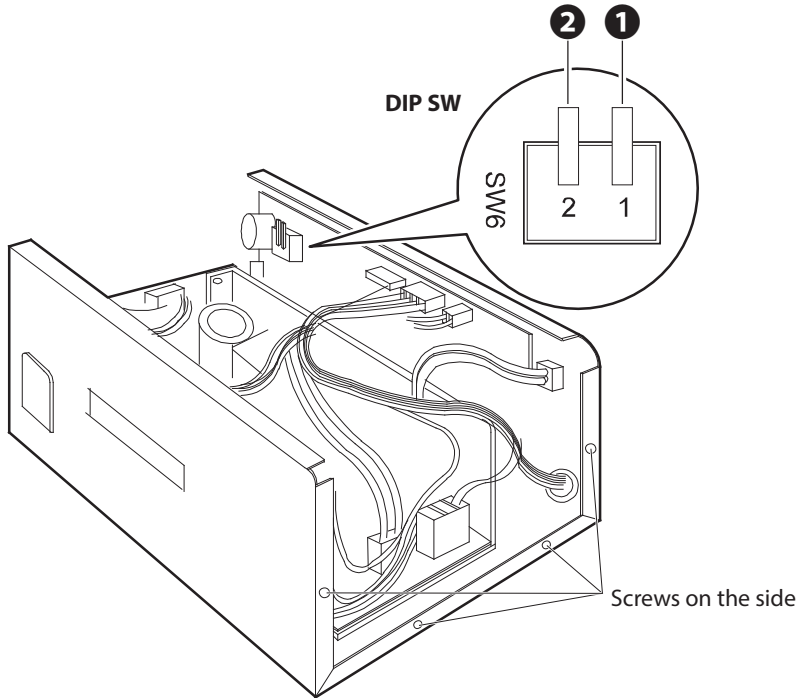

### ❶ SW of the buzzer

This can sound or mute the buzzer.

- ON: sound
- OFF: mute

### ❷ SW for reading/pulse start

This can switch the start mode.

- ON: pulse start (factory setting)
- OFF: reading start

## Switching Between Reading Start and Pulse Start

---

1. Turn off the power of this unit and unplug the power cable from the outlet.
2. Remove the screwdriver cord from the connector.
3. Unscrew eight screws on the side and remove the cover of the unit.
4. Change the SW6-NO.2 on the board on the front side inside the unit.  
Be careful that nothing is left inside of BLT-AY-61/BLT-AY-71.
5. After completion, attach the cover.



## Change the Operational Settings of the Automatic Screwdriver

To change the settings of the automatic screwdriver, input RESET and turn off all the operation display LEDs by cancelling the inputs such as 2WS.

### ■ Basic Setting Procedure

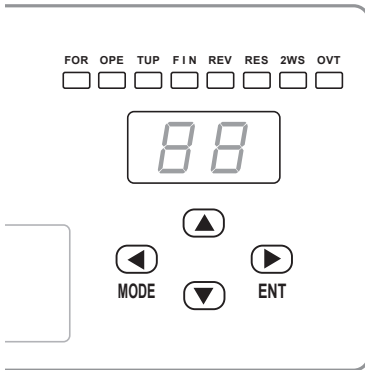

- 1 Press and hold the ◀ button.**
  - The buzzer sounds twice in 2 seconds and the setting mode starts.
  - The operation display LED and the setting display segments are lit.
- 2 Press the ▶ to select a target item.**
  - The operation display LED and the setting display 7-segment will change.
  - For the setting items, see P.10.
- 3 Press ▲ / ▼ to change the setting value.**
  - For the setting value, see P.10.
- 4 Press and hold the ◀ button.**
  - The buzzer sounds twice after 2 seconds and the setting mode ends.
  - The operation display LED and the setting display segments turn off.

## List of Setting Items and Setting Values

### Rotation setting HIGH

#### Setting of the number of impacts for forward rotation and torque-up trigger

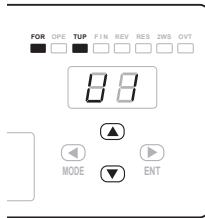

This is to set the number of impacts in forward rotation and the type of torque-up trigger.

When U0/d0 is set, impacts continued to be applied without torque up.

##### Setting value (initially U1)

U: Up trigger

d: DOWN trigger

0 to 4: the number of impacts



#### Setting of the number of impacts for reverse rotation and torque-up trigger

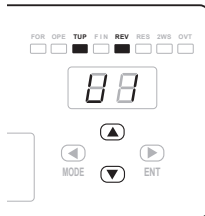

This is to set the number of impacts in reverse rotation and the type of torque-up trigger.

When U0/d0 is set, impacts continued to be applied without torque up.

##### Note:

When reverse rotation is used for the screwdriver specified with the forward rotation, never fail to set this U0 or d0.

##### Setting value (initial value: U0)

U: UP trigger

d: DOWN trigger

0 to 4: the number of impacts



#### Setting of rotation speed

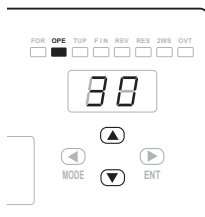

This sets the high rotation speed among 11 steps. For details of setting value and rotation speed, see P.12.

##### Setting value (initial value: 30)

20 to 30

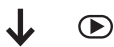

#### Overtime setting



If the automatic screwdriver keeps rotating, this stops it automatically to protect this unit and the screwdriver.

Usually, set this in the program on the system including PLC.

##### Setting value (initial value: t0)

t0 to t9 (t1: about 10 sec. to t9: about 90 sec., t0: about 42 minutes)

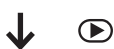

To LOW

### Setting of the number of impacts for forward rotation and torque-up trigger

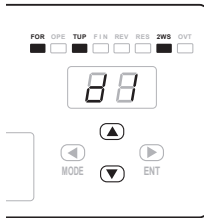

This sets the number of impacts in forward rotation and the type of torque-up trigger.

When U0/d0 is set, impacts continued to be applied without torque up.

**Setting value (initial value: d1)**

U: UP trigger

d: DOWN trigger

0 to 4: the number of impacts



### Setting of the number of impacts for reverse rotation and torque-up trigger

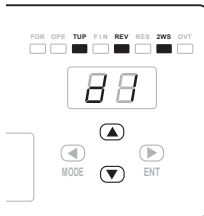

This is to set the number of impacts in reverse rotation and the type of torque-up trigger.

When U0/d0 is set, impacts continued to be applied without torque up.

**! Note:**

When reverse rotation is used for the screwdriver specified with the forward rotation, never fail to set this U0 or d0.

**Setting value (initial value: d0)**

U: UP trigger

d: DOWN trigger

0 to 4: the number of impacts



### Setting of rotation speed

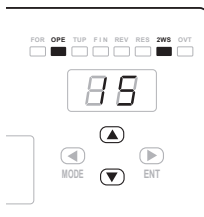

This sets the low rotation speed among 11 steps. For details of setting values and rotation speeds, see P.12.

**Setting value (initial value: 15)**

05 to 15

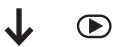

### Setting of overtime



If the automatic screwdriver keeps rotating, this stops it automatically to protect this unit and the screwdriver.

Usually, set this in the program on the system including PLC.

**Setting value (initial value: t0)**

t0 to t9 (t1: about 10 sec. to t9: about 90 sec., t0: about 42 minutes)

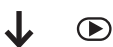

## Relation Between the Rotation Number and Torque of the Automatic Screwdriver



### Note:

These values are only for reference, and they do not guarantee actual performances.

- Set the number of rotations to  $\pm 10\%$  of a specified value.
- The number of rotations was measured as free run. The number of rotations varies depending on the load over 27.
- The number of rotations may fluctuate between forward and reverse rotations.
- The torque was measured by a combination of our torque meter and Fidaptor.
- The reference table of output torque is listed in the instruction manual of the automatic screwdriver. Refer to them at the same time.
- If the overload protection works, change the rotation setting.

### ■ BLF-2000/BLF-5000

Rotation setting		BLF-2000*1			BLF-5000		
		r.p.m	Torque (N·m)		r.p.m	Torque (N·m)	
			max.	min.		max.	min.
LOW	05	120	0.35	0.03	115	0.6	0.3
	06	150			135		
	07	165			150		
	08	187			180	0.8	
	09	210			195		
	10	232			210		
	11	270			240	1	
	12	285			255		
	13	300			285		
	14	315			300		
	15	345			320		
HI	20	690	0.35	0.03	660	1	0.3
	21	720			690		
	22	750			720		
	23	780			750		
	24	810			780		
	25	825			810		
	26	870			840		
	27	975			940		
	28	975			940		
	29	975			940		
	30	975			940		

\*1 For the torque adjustment spring for BLF-2000, two types are available. The silver spring for high torque (accessory), the black spring for low torque (installed inside of screwdriver). Please select a suitable one for your work.

■ BLF-7000/BLF-7000X/BLF-7025X

Rotation setting		BLF-7000/BLF-7000X			BLF-7025X		
		r.p.m	Torque (N·m)		r.p.m	Torque (N·m)	
			max.	min.		max.	min.
LOW	05	150	1.1	0.7	120	1.4	1.2
	06	180			140		
	07	210			160		
	08	240			180		
	09	270			210		
	10	300	1.5	230	2		
	11	330		250			
	12	360		280			
	13	390		300			
	14	420		320			
	15	450		350			
HI	20	495	2	0.7	400	2.5	
	21	510			420		
	22	540			440		
	23	570			470		
	24	600			490		
	25	615			510		
	26	645			540		
	27	735			600		
	28	735			600		
	29	735			600		
	30	735			600		

■ **PGF-3000/PGF-5000/PGF-7000**

Rotation setting		PGF-3000	PGF-5000	PGF-7000
		r.p.m	r.p.m	r.p.m
<b>LOW</b>	05	115	115	210
	06	135	135	250
	07	155	155	285
	08	175	175	325
	09	200	200	365
	10	220	215	400
	11	240	240	440
	12	260	260	480
	13	280	280	520
	14	300	300	555
<b>HI</b>	15	325	320	595
	20	625	690	645
	21	655	720	670
	22	700	755	710
	23	730	785	740
	24	765	820	770
	25	800	850	800
	26	840	890	840
	27	950	985	935
	28	950	985	935
29	950	985	935	
30	950	985	935	

## Torque Up Settings

Most customers are undoubtedly experienced in driving a car, and are aware that cars traveling up a slope at a high speed will end up going over the mountain even when the brakes are applied, while cars traveling at a low speed will come to a stop before reaching the top of the mountain when the brakes are applied.

The automatic brushless screwdriver BLF-series uses a system that traverses the lobe of a mechanical cam to apply torque to screws. To ensure that torque is applied to the bit accurately, a clutch is used when traversing the cam. The timing of the application of the brake when the bit is rotating at high speeds and low speeds is required to be adjusted to traverse the lobe of the cam.

The BLT-AY-61/BLT-AY-71 controller is designed to control the rotational speed of the driver over a large range of speeds from low to high, as well as to allow settings for torque up with DOWN trigger at low speeds and UP trigger at high speeds.

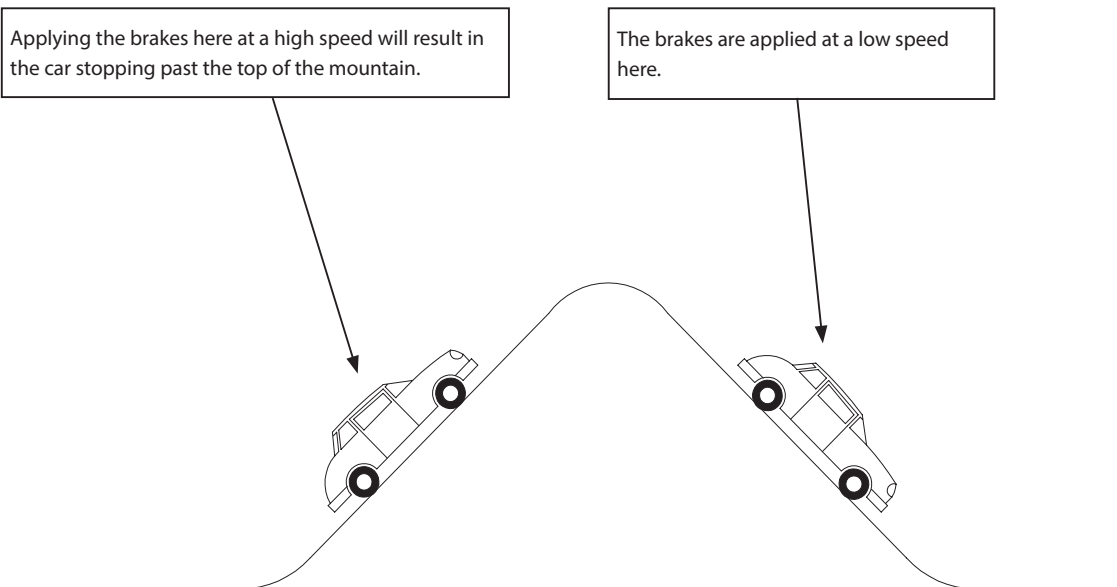

## Clutch Mechanism

The clutch mechanism is described below.

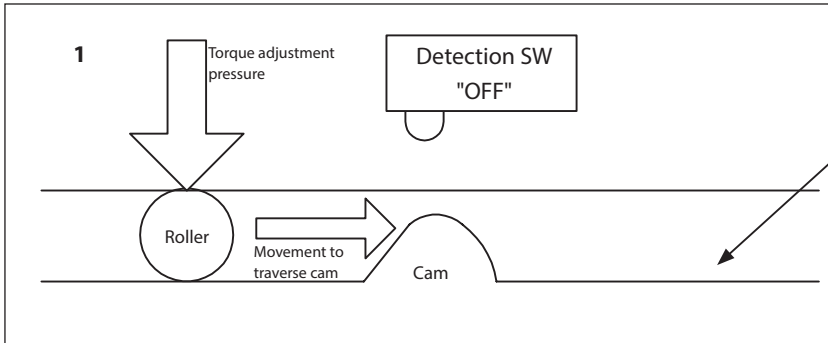
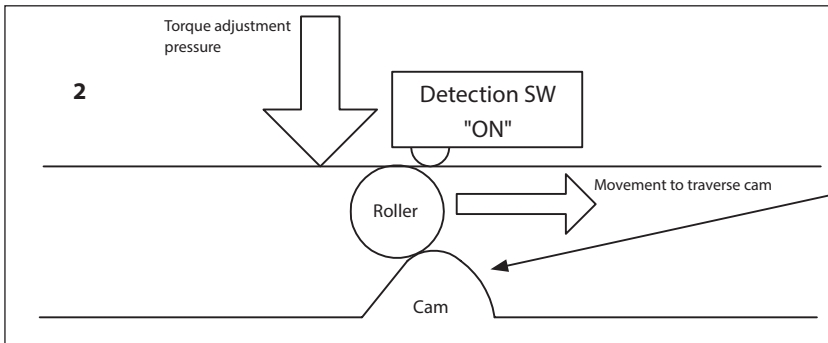
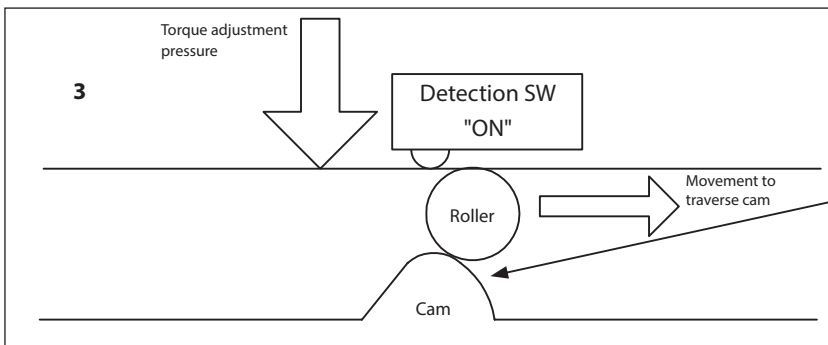

Diagram of the mechanism that allows the driver to detect torque.



If the speed when traversing the cam is high, the detection SW turns ON (before traversing the cam) and the brake is applied to the motor.



If the speed when traversing the cam is low, the detection SW turns OFF (after traversing the cam) and the brake is applied to the motor.

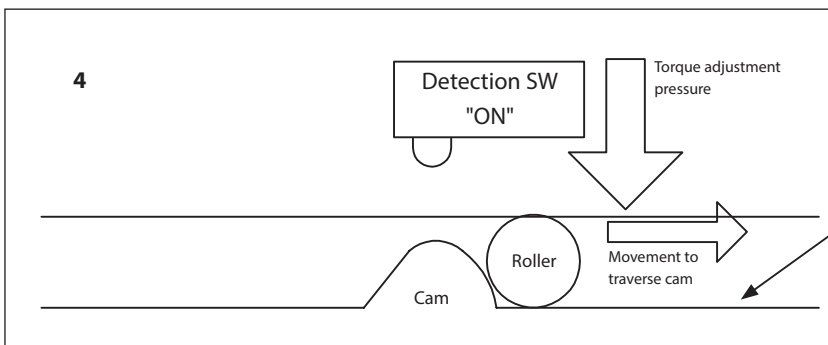

By traversing the cam, torque is transferred accurately and the screw is completely tightened.



## Timing Chart Table

 **Note:**

- If a pulse input is to be used for START and RESET, always use an input of 100 mS or more.
- Set the interval between one START and the next START to 100 mS or more for the reading START settings.
- Do not change the external input during torque up operations (impact).
- Always control the input sequence in a single direction when switching between forward and reverse rotation.

No.	Start Type	Impact setting value				2WS setting	Bit rotation
		FOR/HIGH	FOR/LOW	REV/HIGH	REV/LOW		
Timing Chart 01	Pulse Start	U1	–	–	–	HIGH	FOR
Timing Chart 02	Pulse Start	U3	–	–	–	HIGH	FOR
Timing Chart 03	Pulse Start	–	d1	–	–	LOW	FOR
Timing Chart 04	Pulse Start	–	d3	–	–	LOW	FOR
Timing Chart 05	Pulse Start	U1	–	–	–	LOW→HIGH	FOR
Timing Chart 06	Pulse Start	–	d1	–	–	HIGH→LOW	FOR
Timing Chart 07*	–	–	–	U1	d1	LOW→HIGH	REV
Timing Chart 08*	–	–	–	U1	d1	HIGH→LOW	REV
Timing Chart 09*	Pulse Start	U1	–	–	–	HIGH	REV→FOR
Timing Chart 10*	Pulse Start	–	–	U1	–	HIGH	FOR→REV
Timing Chart 11*	Reading Start	U1	–	–	–	HIGH	FOR
Timing Chart 12*	Reading Start	U3	–	–	–	HIGH	FOR
Timing Chart 13*	Reading Start	–	d1	–	–	LOW	FOR
Timing Chart 14*	Reading Start	–	d3	–	–	LOW	FOR
Timing Chart 15*	Reading Start	U1	–	–	–	LOW→HIGH	FOR
Timing Chart 16*	Reading Start	–	d1	–	–	HIGH→LOW	FOR
Timing Chart 17*	Reading Start	U1	–	–	–	HIGH	REV→FOR
Timing Chart 18*	Reading Start	–	–	U1	–	HIGH	FOR→REV

\* The timing charts are applied to screwdrivers for counter-clock-wise for automatic BLF brushless screwdriver. Please note that they are not applied to standard types.

## ■ Timing Chart 01

Start Type	Impact setting value				2WS setting	Bit rotation
	FOR/ HIGH	FOR/ LOW	REV/ HIGH	REV/ LOW		
Pulse start	U1	—	—	—	HIGH only	FOR only

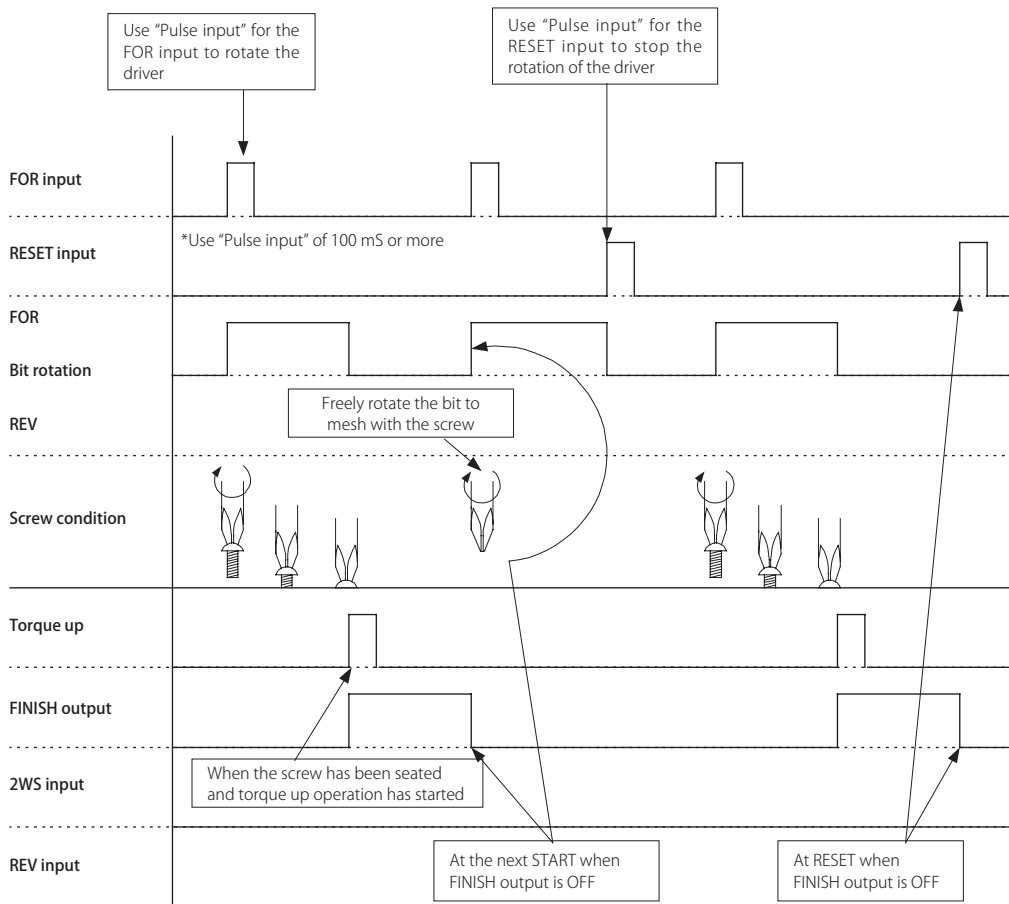

## ■ Timing Chart 02

Start Type	Impact setting value				2WS setting	Bit rotation
	FOR/ HIGH	FOR/ LOW	REV/ HIGH	REV/ LOW		
Pulse start	U3	—	—	—	HIGH only	FOR only

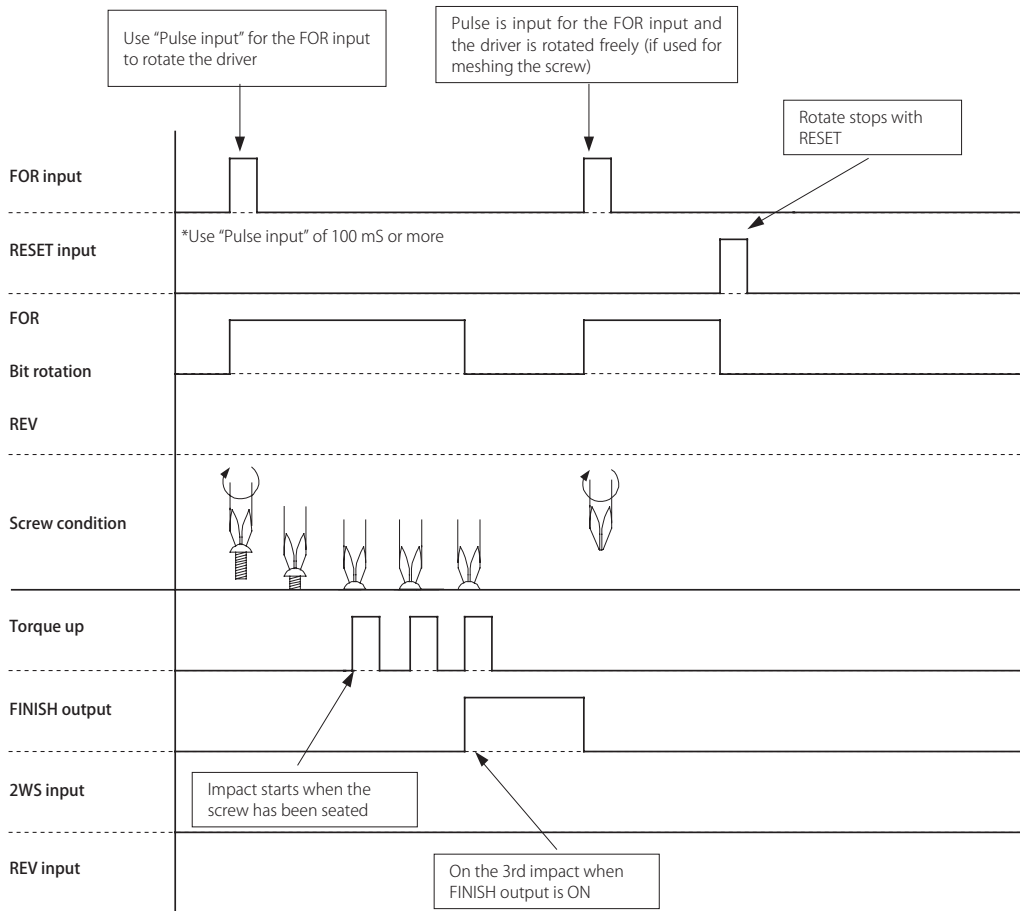

## ■ Timing Chart 03

Start Type	Impact setting value				2WS setting	Bit rotation
	FOR/ HIGH	FOR/ LOW	REV/ HIGH	REV/ LOW		
Pulse start	—	d1	—	—	LOW only	FOR only

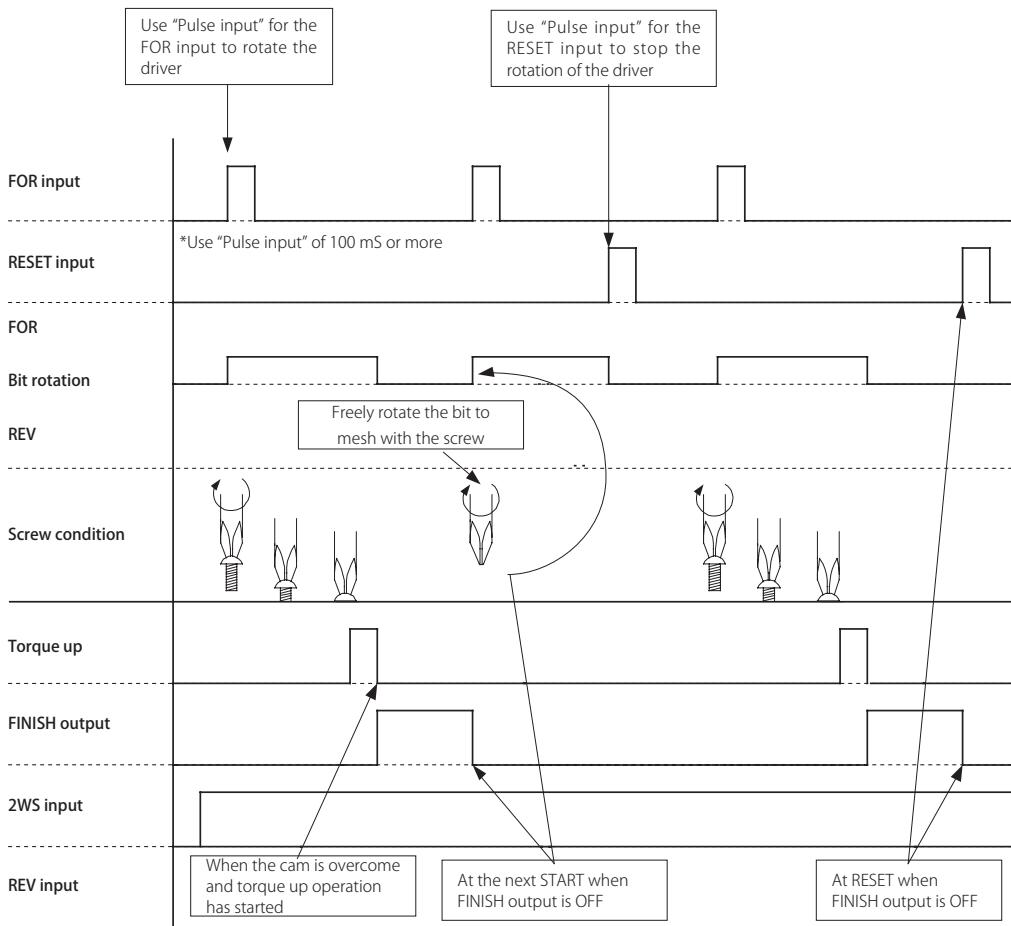

## ■ Timing Chart 04

Start Type	Impact setting value				2WS setting	Bit rotation
	FOR/ HIGH	FOR/ LOW	REV/ HIGH	REV/ LOW		
Pulse start	—	d3	—	—	LOW only	FOR only

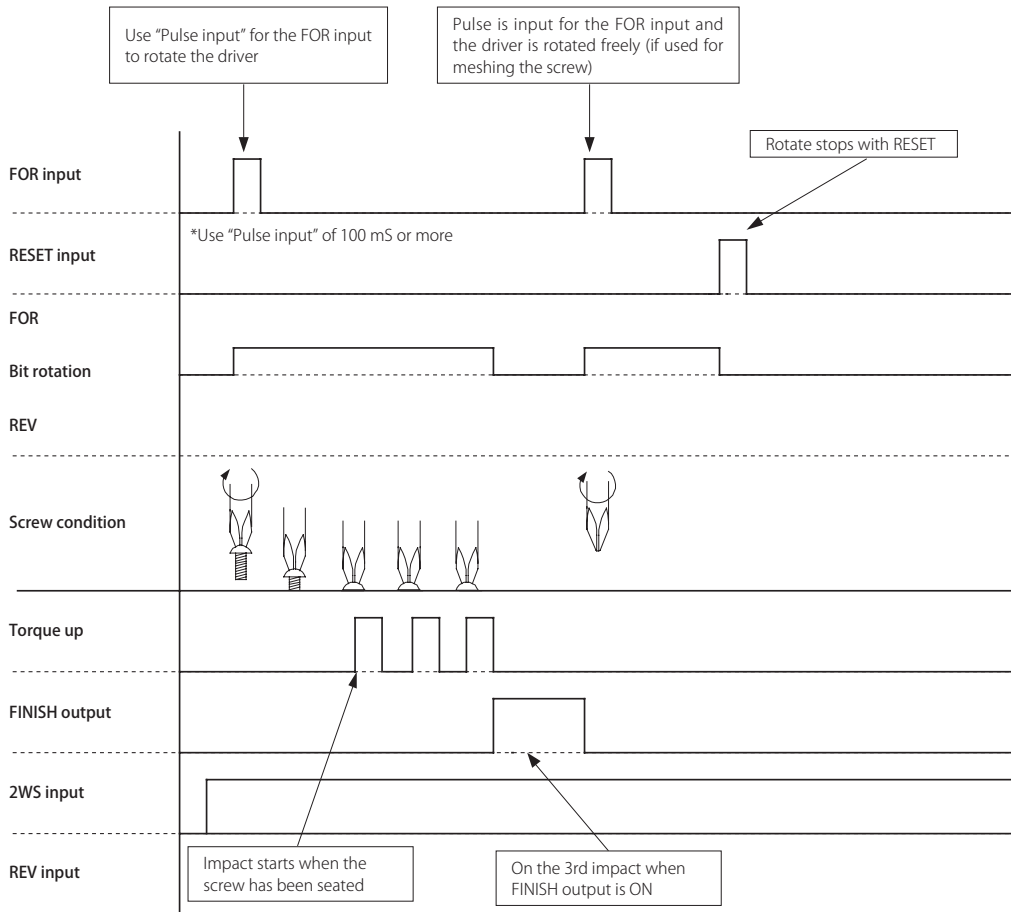

## ■ Timing Chart 05

Start Type	Impact setting value				2WS setting	Bit rotation
	FOR/ HIGH	FOR/ LOW	REV/ HIGH	REV/ LOW		
Pulse start	U1	—	—	—	LOW → HIGH	FOR only

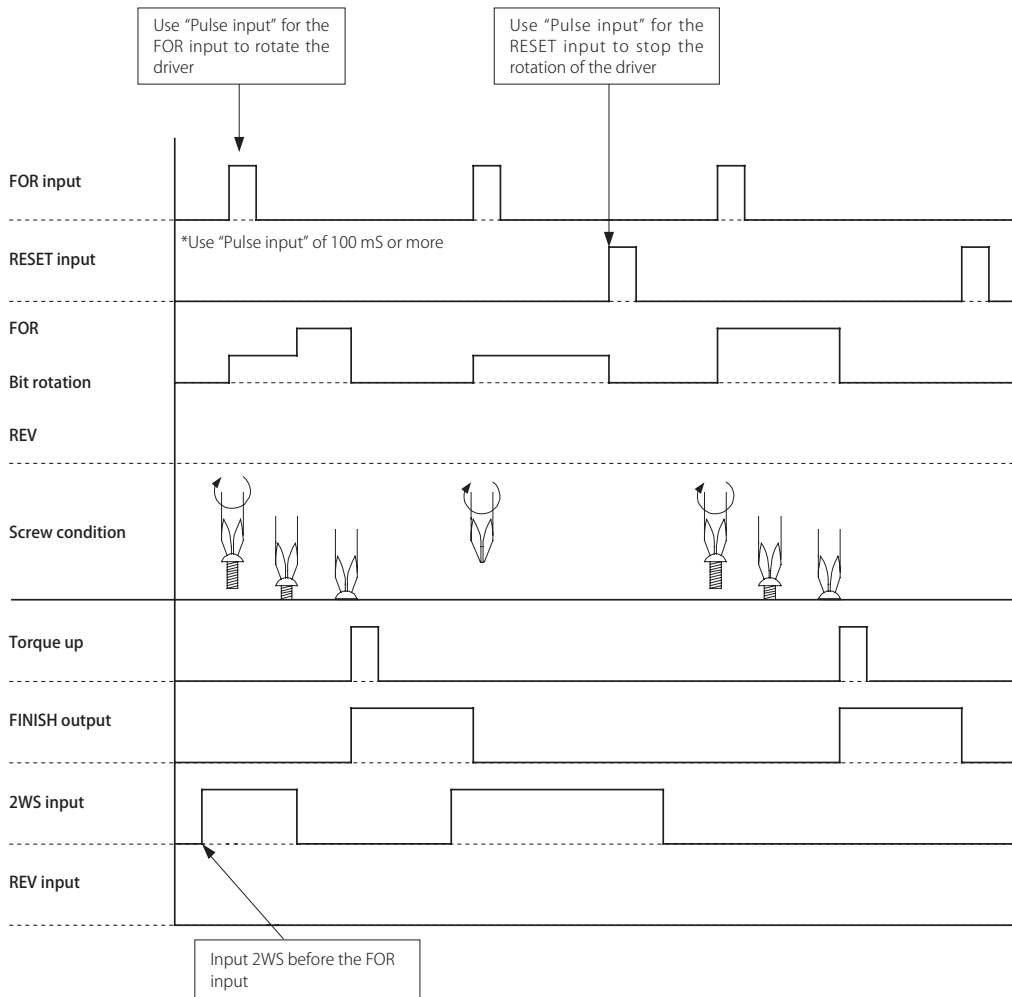

## ■ Timing Chart 06

Start Type	Impact setting value				2WS setting	Bit rotation
	FOR/ HIGH	FOR/ LOW	REV/ HIGH	REV/ LOW		
Pulse start	—	d1	—	—	HIGH → LOW	FOR only

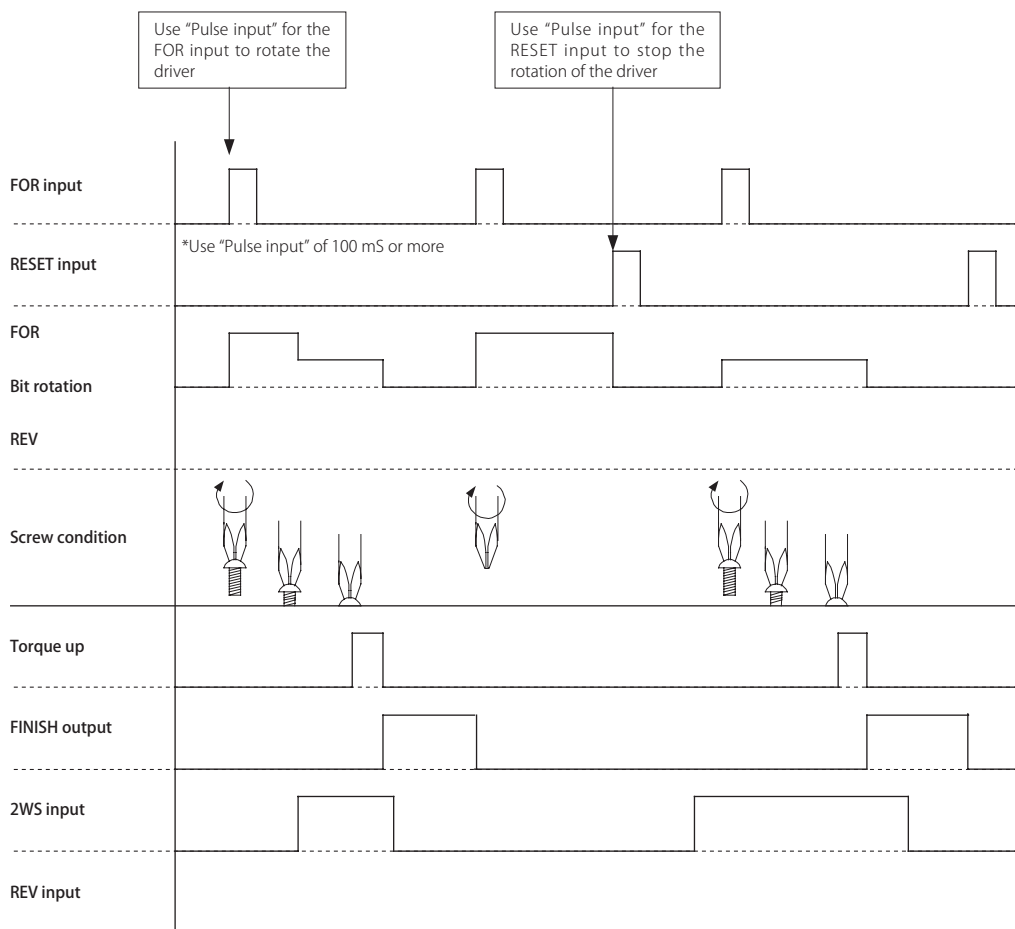

## ■ Timing Chart 07

Start Type	Impact setting value				2WS setting	Bit rotation
	FOR/ HIGH	FOR/ LOW	REV/ HIGH	REV/ LOW		
—	—	—	U1	d1	LOW → HIGH	REV only

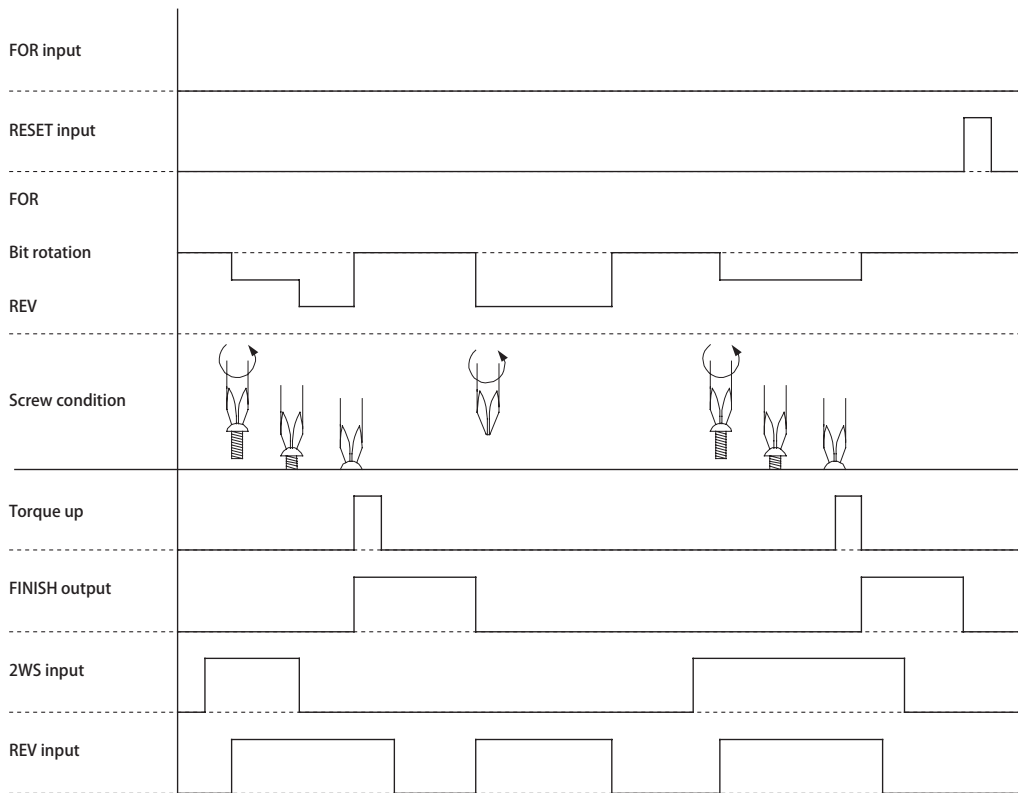

The timing charts are applied to screwdrivers for counter-clock-wise for automatic BLF brushless screwdriver.  
Please note that they are not applied to standard types.



## ■ Timing Chart 08

Start Type	Impact setting value				2WS setting	Bit rotation
	FOR/ HIGH	FOR/ LOW	REV/ HIGH	REV/ LOW		
—	—	—	U1	d1	HIGH → LOW	REV only

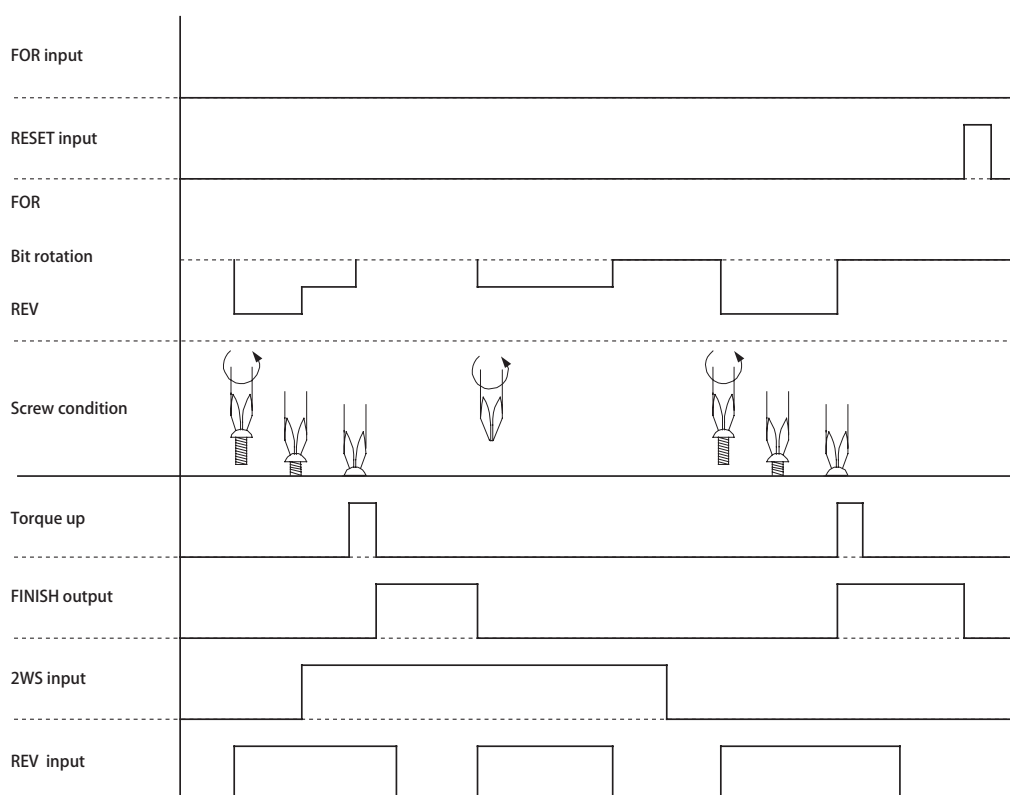

The timing charts are applied to screwdrivers for counter-clock-wise for automatic BLF brushless screwdriver.  
Please note that they are not applied to standard types.

## ■ Timing Chart 09

Start Type	Impact setting value				2WS setting	Bit rotation
	FOR/ HIGH	FOR/ LOW	REV/ HIGH	REV/ LOW		
Pulse start	U1	—	—	—	HIGH only	REV → FOR

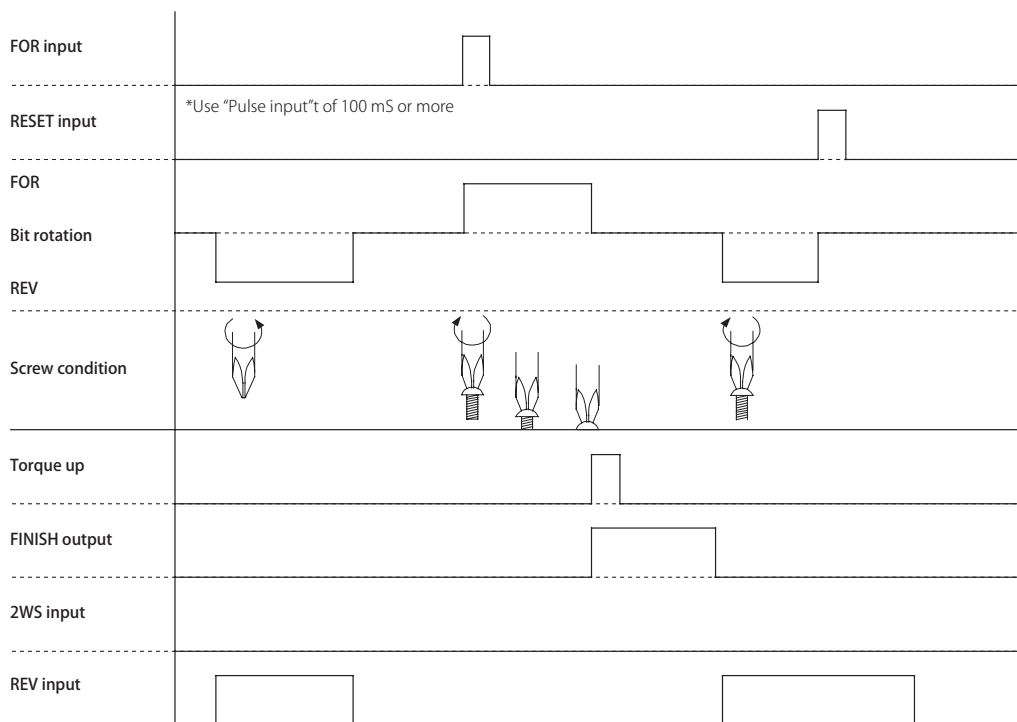

## ■ Timing Chart 10

Start Type	Impact setting value				2WS setting	Bit rotation
	FOR/ HIGH	FOR/ LOW	REV/ HIGH	REV/ LOW		
Pulse start	—	—	U1	—	HIGH only	FOR → REV

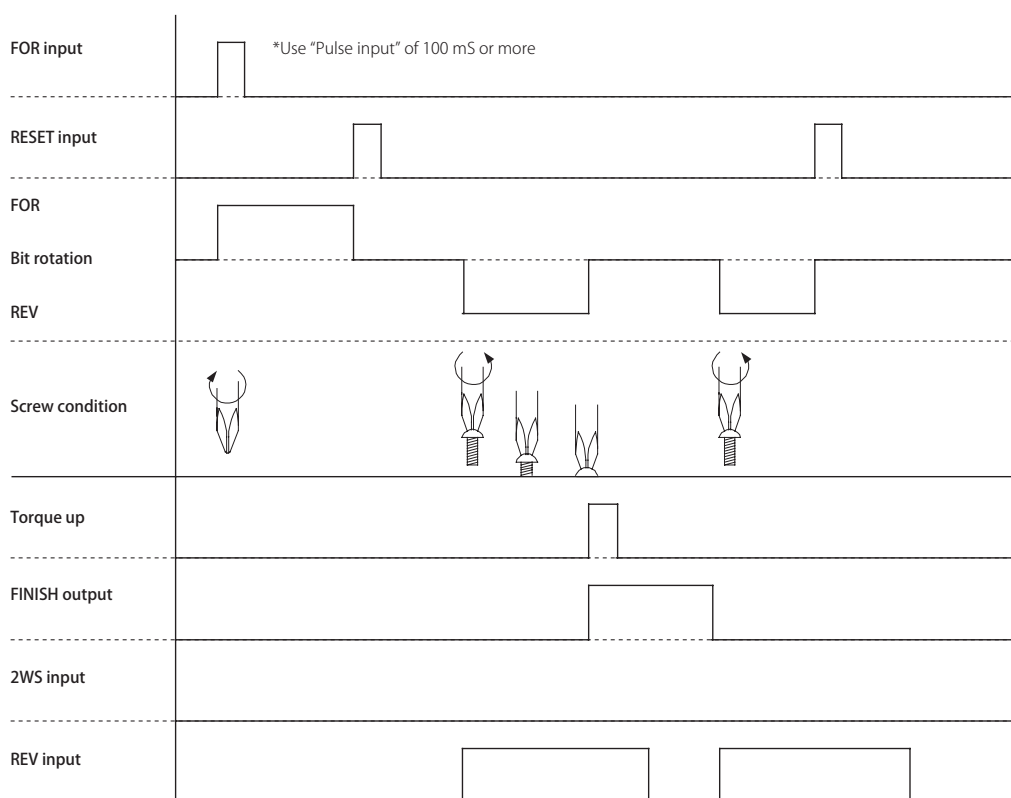

The timing charts are applied to screwdrivers for counter-clock-wise for automatic BLF brushless screwdriver.  
Please note that they are not applied to standard types.

## ■ Timing Chart 11

Start Type	Impact setting value				2WS setting	Bit rotation
	FOR/ HIGH	FOR/ LOW	REV/ HIGH	REV/ LOW		
Reading start	U1	—	—	—	HIGH only	FOR only

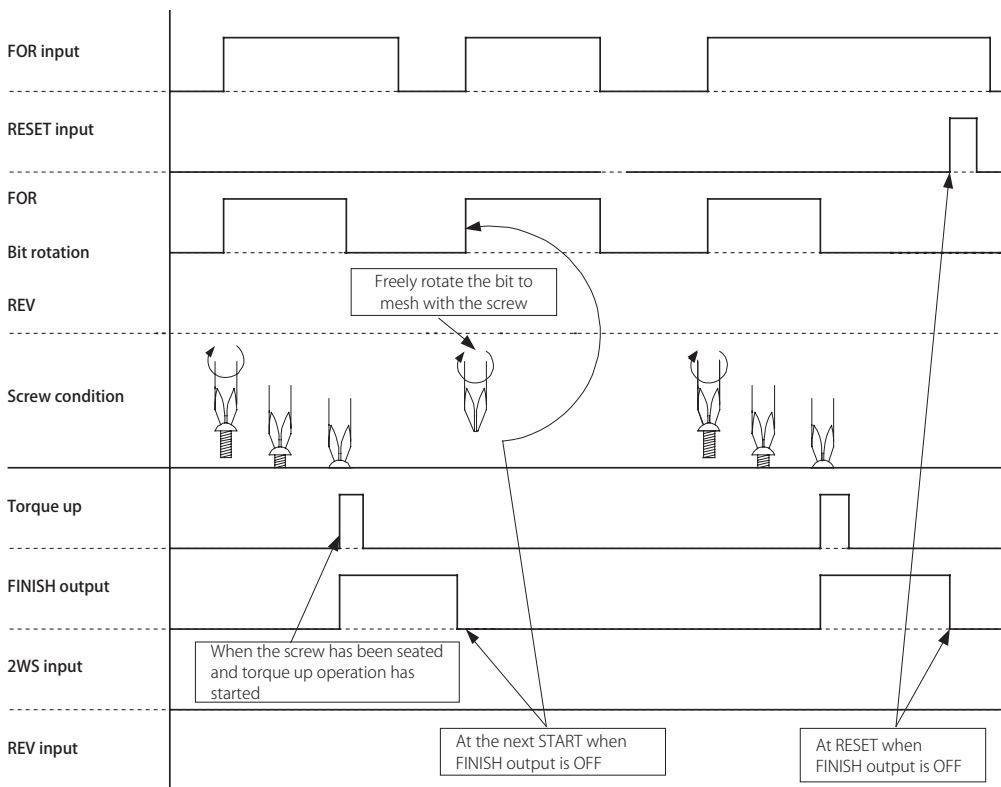

## ■ Timing Chart 12

Start Type	Impact setting value				2WS setting	Bit rotation
	FOR/ HIGH	FOR/ LOW	REV/ HIGH	REV/ LOW		
Reading start	U3	—	—	—	HIGH only	FOR only

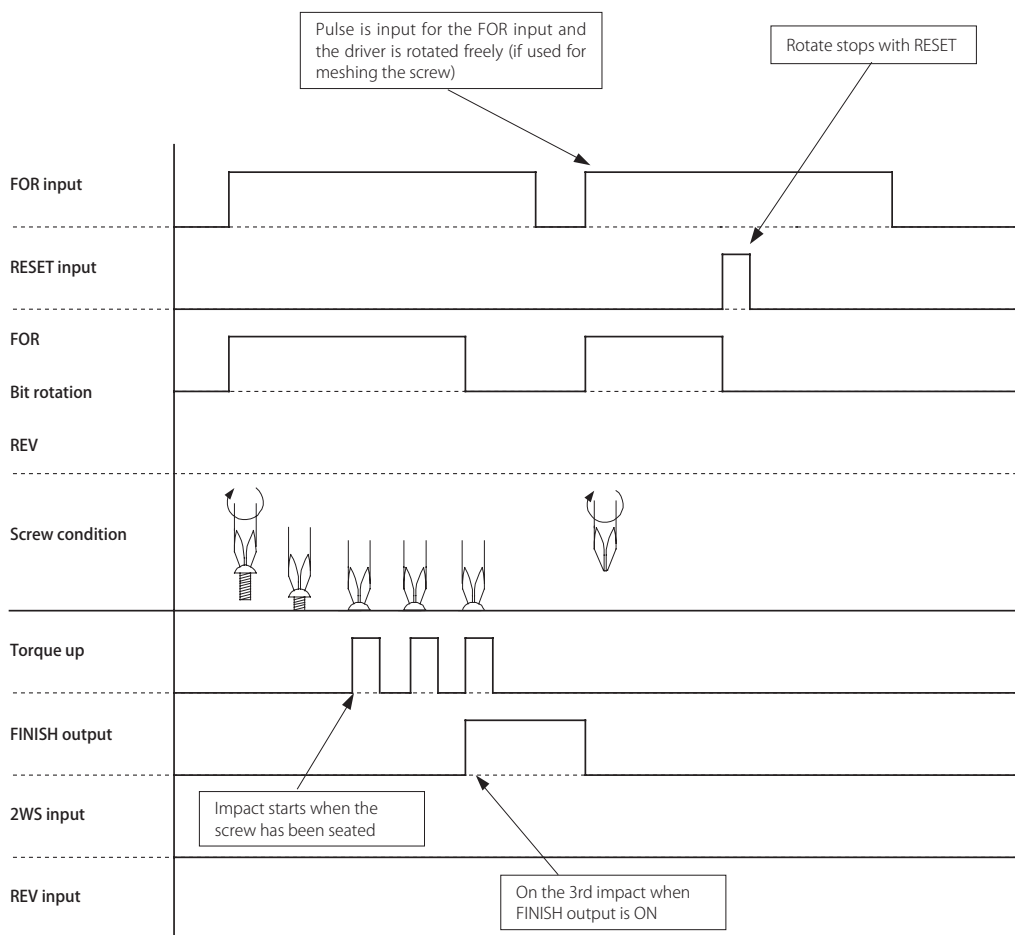

## ■ Timing Chart 13

Start Type	Impact setting value				2WS setting	Bit rotation
	FOR/ HIGH	FOR/ LOW	REV/ HIGH	REV/ LOW		
Reading start	—	d1	—	—	LOW only	FOR only

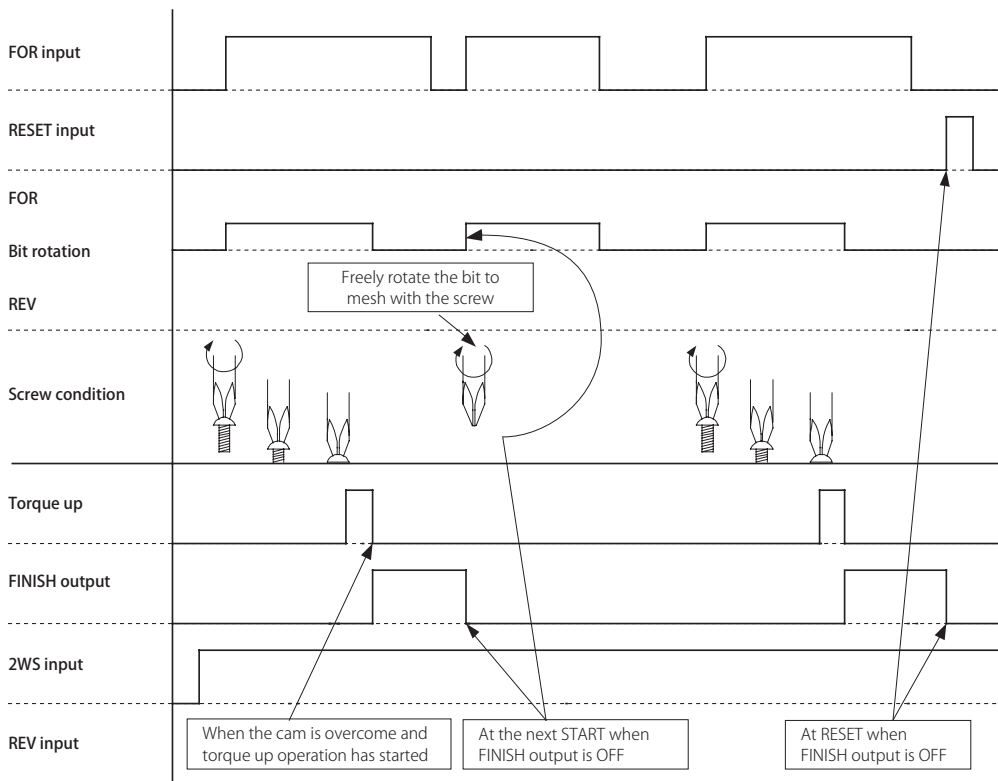

## ■ Timing Chart 14

Start Type	Impact setting value				2WS setting	Bit rotation
	FOR/ HIGH	FOR/ LOW	REV/ HIGH	REV/ LOW		
Reading start	—	d3	—	—	LOW only	FOR only

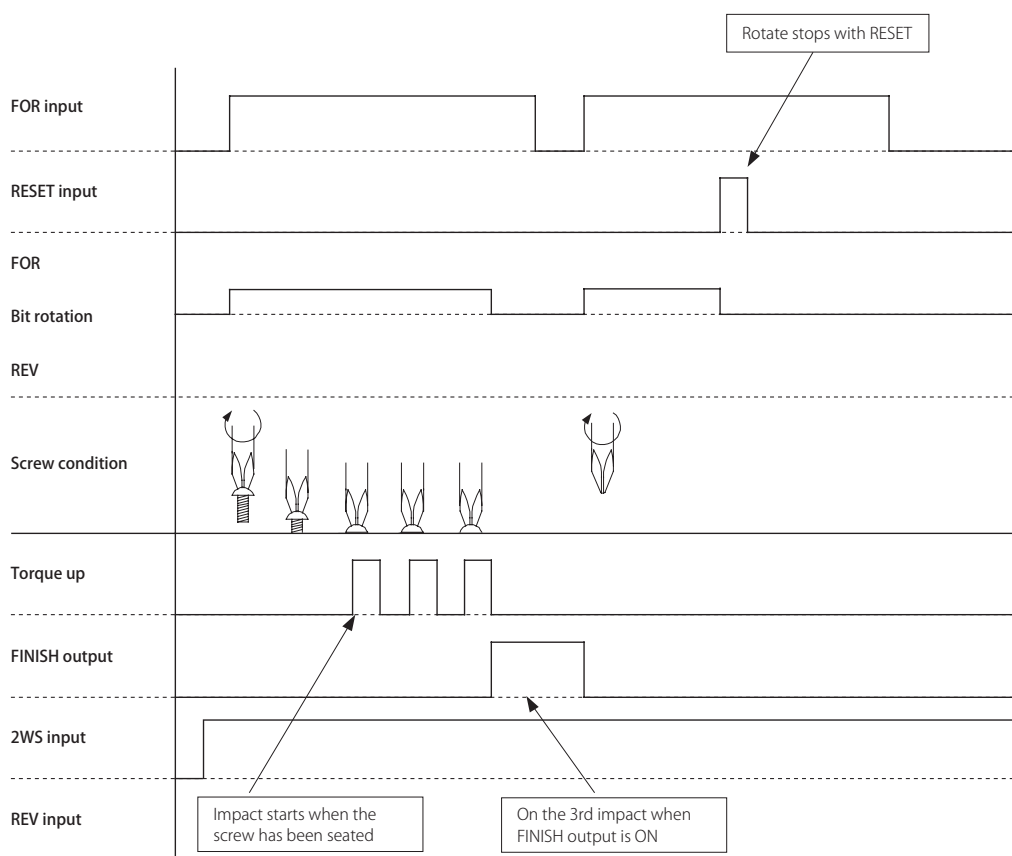

## ■ Timing Chart 15

Start Type	Impact setting value				2WS setting	Bit rotation
	FOR/ HIGH	FOR/ LOW	REV/ HIGH	REV/ LOW		
Reading start	U1	—	—	—	LOW → HIGH	FOR only

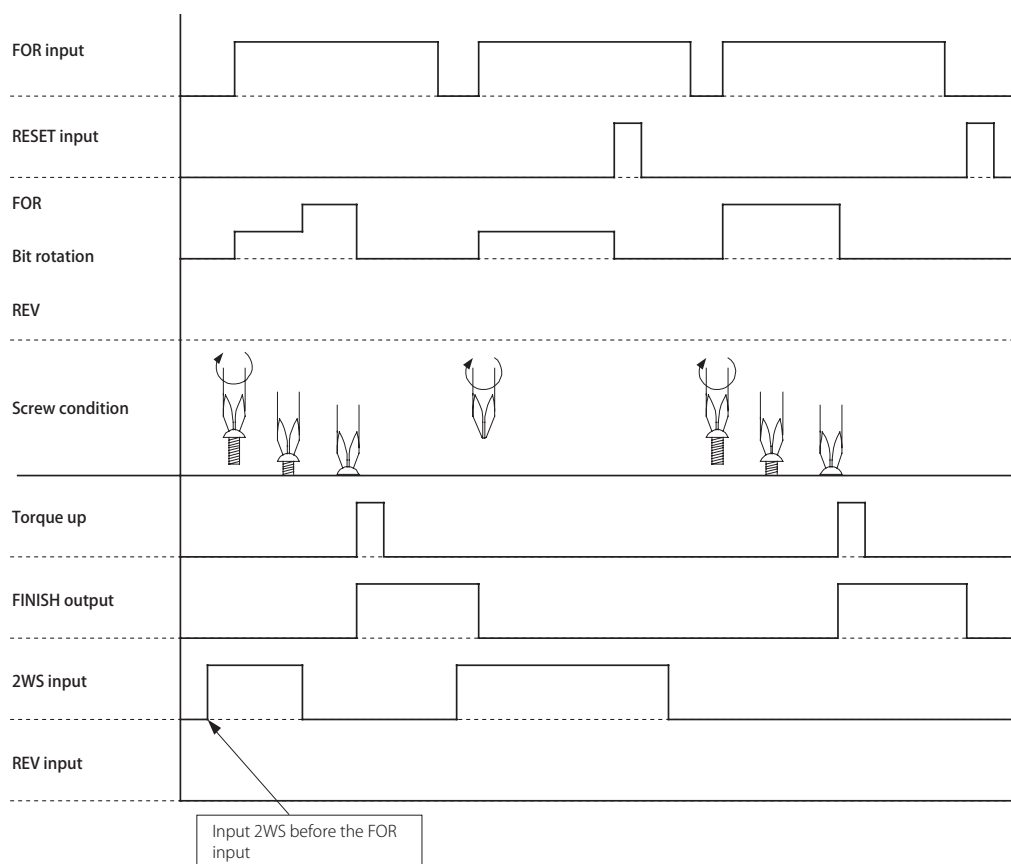



## ■ Timing Chart 16

Start Type	Impact setting value				2WS setting	Bit rotation
	FOR/ HIGH	FOR/ LOW	REV/ HIGH	REV/ LOW		
Reading start	—	d1	—	—	HIGH → LOW	FOR only

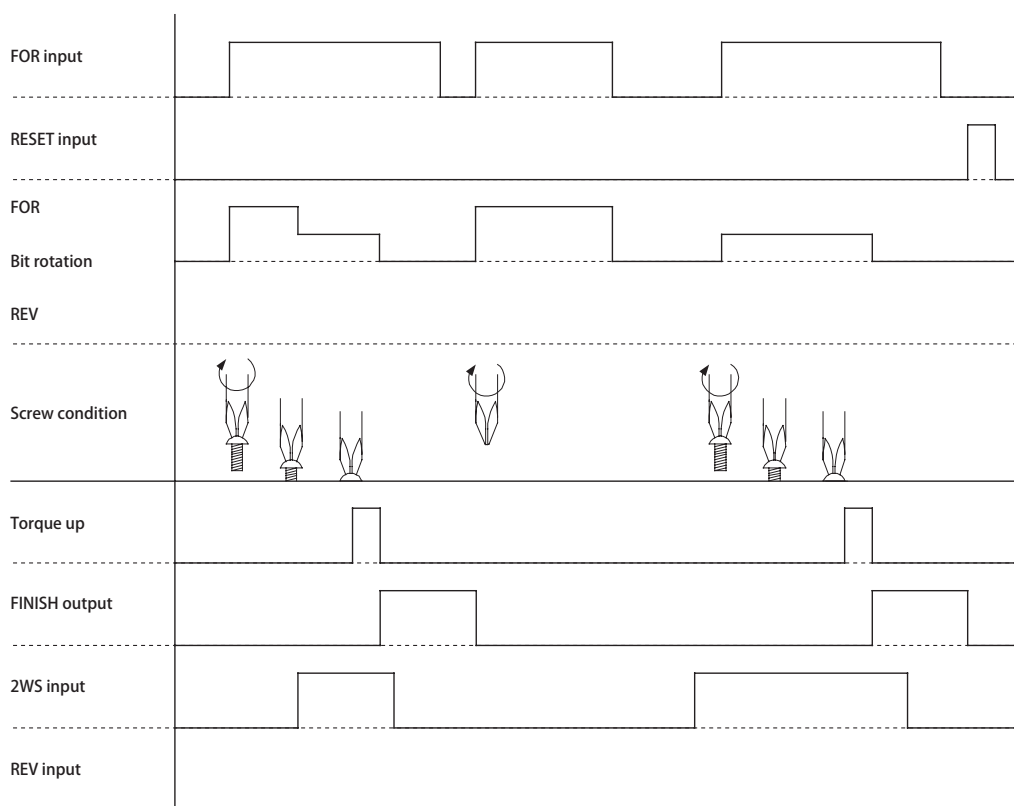

## ■ Timing Chart 17

Start Type	Impact setting value				2WS setting	Bit rotation
	FOR/ HIGH	FOR/ LOW	REV/ HIGH	REV/ LOW		
Reading start	U1	—	—	—	HIGH only	REV → FOR

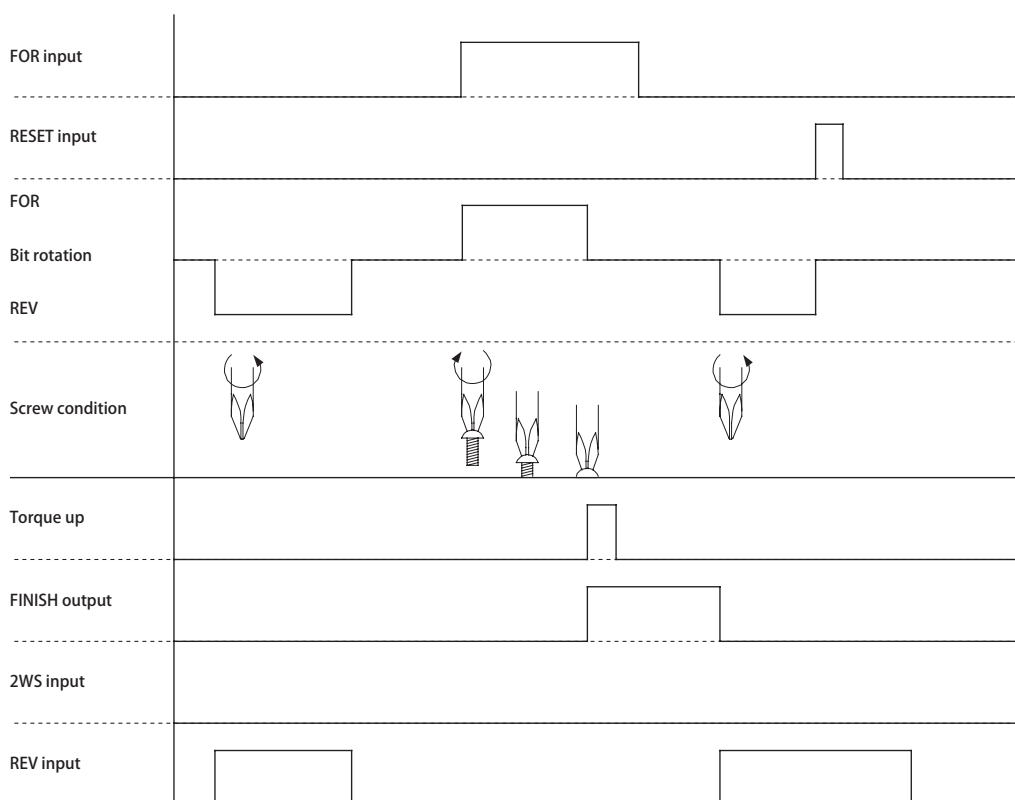

## ■ Timing Chart 18

Start Type	Impact setting value				2WS setting	Bit rotation
	FOR/ HIGH	FOR/ LOW	REV/ HIGH	REV/ LOW		
Reading start	—	—	U1	—	HIGH only	FOR → REV

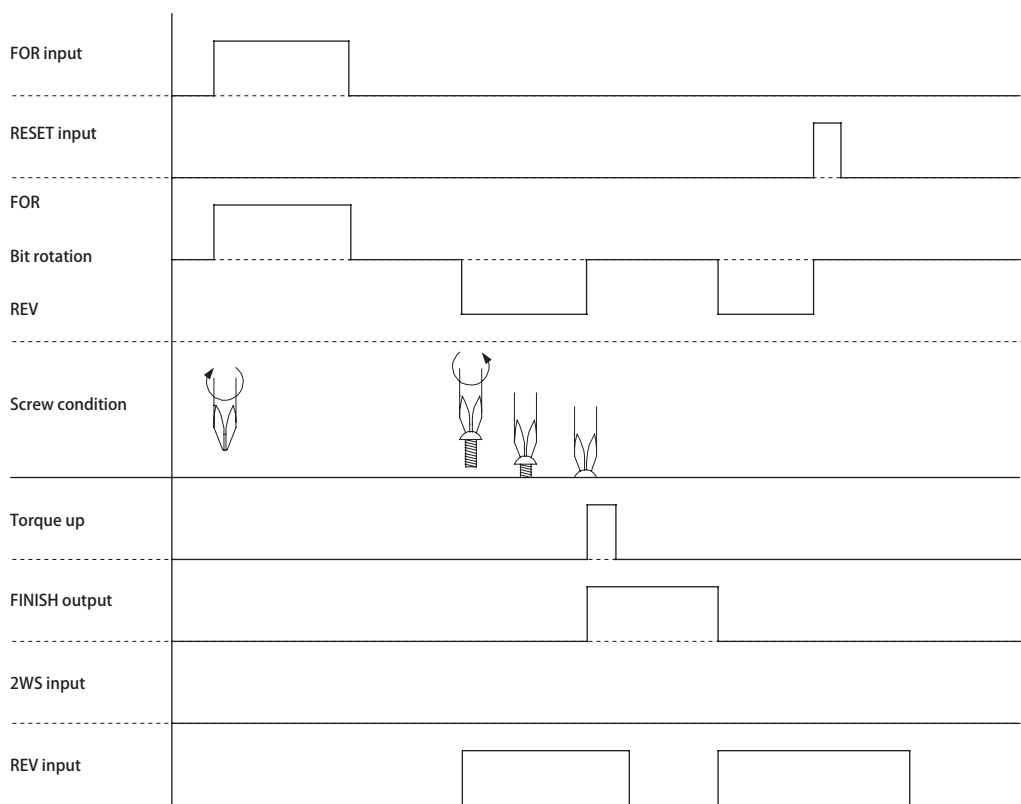

The timing charts are applied to screwdrivers for counter-clock-wise for automatic BLF brushless screwdriver.  
Please note that they are not applied to standard types.

## Specifications

Please note that this unit is subject to change for improvement without any prior notice.

Model		BLT-AY-61	BLT-AY-71
Primary input power source		AC100 to 240V (47-63Hz)	
Power supply capacity (fuse capacity)		100W 3A / 250V (1 spare fused below AC-Inlet)	
Secondary output voltage		LOW: 5V to 15V, HI: 20V to 30V (11 steps each)	
Dimensions		See the outline drawing.	
Weight		1.75kg	
Compatible screwdriver (One-unit control)	BLF	BLF-2000/BLF-5000	BLF-7000/BLF-7000X/BLF-7025X
	PGF	PGF-3000/PGF-5000	PGF-7000
Rotation setting		LOW: 05 to 15, HIGH: 20 to 30 (11 steps each)	
The number of rotations of automatic screwdriver (r.p.m)		BLF-2000/BLF-5000 (See P.12) PGF-3000/PGF-5000 (See P.14)	BLF-7000 series (See P.13) PGF-7000 (See P.14)
Rotation control directions		Forward and reverse*	
Accessories		Power cord: 1 (1.8m with GND (3L2P cord)) Terminal block connector: 1	



### Note:

- Torque-up for reverse rotation is not available for a standard automatic screwdriver because the one-way clutch works.
- For tightening reverse thread screws, a special automatic screwdriver for reserve thread screws is required.
- When using the forward rotation screwdriver for reverse rotation, set the reverse torque-up to U0 or d0 (for example, when engaging a screw with the bit)

## External Dimensions

The external dimensions of BLT-AY-61 are the same as those of BLT-AY-71.

mm

Front

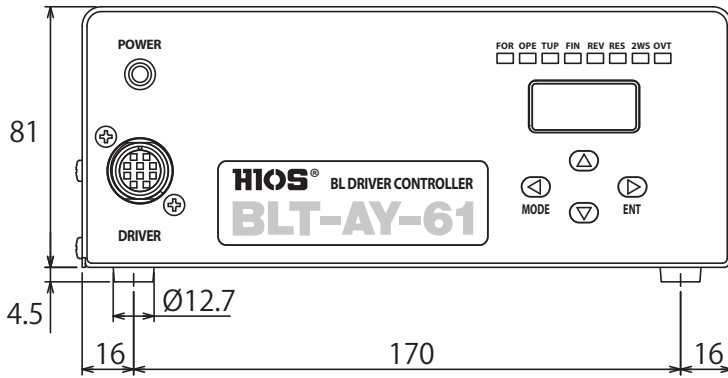

Top

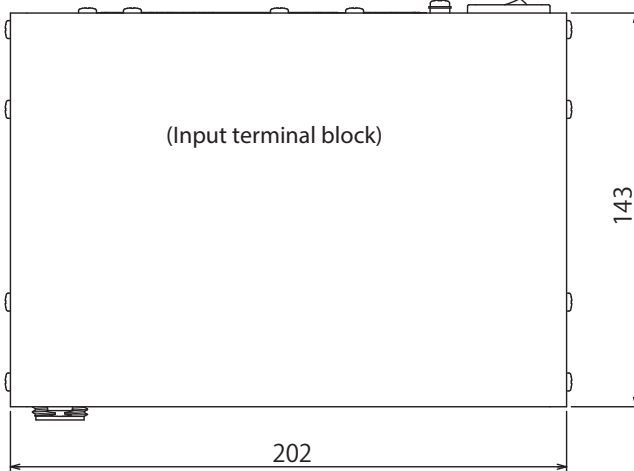

Side

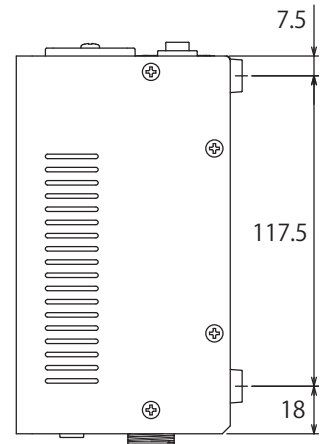

**Note:**

The external dimensions are not full size.

## Terminology Related to This Unit

### Confirmation tightening (setting of the impact number)

To make sure if a screw has been tightened firmly, it is retightened two or three times after tightening. It is also called double tightening or retightening.

### Torque-up

When a screw is tightened completely and the tightening torque reaches the set torque, the clutch of the automatic screwdriver disengages.

### UP trigger

While the bit is rotating at high speed, this is used for an operational signal of the clutch that is received on the uphill slope of the cam.

### DOWN trigger

While the bit is rotating at low speed, this is used for an operational signal of the clutch that is received on the downhill slope of the cam.

### Input method

- The signal input method of this unit uses a photo coupler. The maximum input current is 10 mA.
- In case of an open collector connection, connect a collector to the input and GND to the emitter.



#### Note:

- Do not apply voltage to the input. Add a diode for reverse voltage absorption to the relay coil of the input contact.
- When using an external device, take measures against noises.

### Output method

The output signal of this unit uses a dry contact output common to internal GND on one side with the maximum rated load being 24 VDC / 500 mA. Use GND as the common terminal when connecting an external device.



#### Note:

When a relay is connected to the output, add a diode for reverse voltage absorption. When using an external device, take measures against noises.

### Overload protection

This is to protect this unit and the automatic screwdriver.

If excessive current is generated in the motor due to overload to the working automatic screwdriver, the output is stopped to protect the automatic screwdriver.

### Abbreviations

---

The following product names used in this manual are abbreviated.

- Power supply dedicated for automatic brushless screwdriver → Power supply for automatic screwdriver
- Brushless screwdriver for automation → Automatic screwdriver or brushless screwdriver
- In the timing chart, the automatic screwdriver is referred as "screwdriver."
- To indicate 3 models of BLF-7000, BLF-7000X and BLF-7025X → the BLF-7000 series

## China RoHS2 Table

If you are asked by China Customs, please show this table to them.

有害物质名称及含量标识格式						
产品中有害物质的名称及含量						
部件名称	有害物质					
	铅(pb)	汞(Hg)	镉(Cd)	六价铬 (CR(VI))	多溴联苯 (PBB)	多溴二苯醚 (PBDE)
电路板总成	×	○	○	○	○	○
外壳	○	○	○	○	○	○
螺丝刀线	×	○	○	○	○	○
-						
-						
-						
-						
-						

本表格依据 SJ/T 11364 的规定编制。  
 ○：表示该有害物质在该部件所有均质材料中的含量均在 GB/T 26572 规定的限量要求以下。  
 ×：表示该有害物质至少在该部件的某一均质材料中的含量超出 GB/T 26572 规定的限量要求。

In addition, the China RoHS marks also is required at the product and product box.

At the product, you can find it at the bottom and it is marked on the product box.

If you cannot find the mark, please ask your distributor.

In case of emergency, please cut the mark below and stick at the bottom of product and on the product box.

China RoHS mark

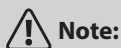

**Note:**

Minimum size of China RoHS mark is 5mm at outer diameter.

**HIOS<sup>®</sup>**

**HIOS Inc.**

---

1-16-5, Akiyama, Matsudo, Chiba Prefecture, Japan  
<http://www.hios.com>