



Electric Screwdriver Operation Manual

(September, 2015)

Transformerless Screwdriver

VZ SERIES 100V

Lever Start Type VZ-1510

Push To Start Type VZ-1510PS

VZ SERIES 120V

Lever Start Type VZ-1820

VZ-3012

VZ-4506

Push To Start Type VZ-1820PS

VZ-3012PS

VZ-4506PS

HIOS Inc.

111-6, Akiyama, Matsudo City, Chiba, Pref. Japan

TEL. 81-47-392-2001 FAX. 81-47-392-7773

SAVE THESE INSTRUCTIONS

We thank you for your purchase of Hios Electric Screw Driver.

WARNING

When using electric tools, basic safety precautions should always be followed to reduce the risk of fire, electric shock and personal injury, including the following:

READ ALL INSTRUCTIONS

1. **Keep Work Area Clean.**

Cluttered areas and benches invite injuries.

2. **Consider Work Area Environment.**

Don't expose tool to rain. Don't use tool in damp or wet locations.

Keep work area well lit.

Never use the tool at an area with dangerous object. (gasoline, benzene, thinner, gas glue, etc.)

3. **Secure Work.**

Use clamps or vise to hold work. It's safer than using your hand and it free both hands to operate tool.

4. **Guard Against Electric Shock.**

Prevent body contact with grounded surfaces, for example: pipes, radiators, ranges, refrigerator enclosures.

5. **Keep Children Away.**

Do not let visitors contact tool. All visitors should be kept away from work area.

6. **Store Idle Tools.**

When not in use, tools should be stored in dry, and high or locked-up place out of reach of children.

7. **Don't Force Tool.**

It will do the job better and safer at the rate for which it was intended.

8. **Remove Adjusting Keys And Wrenches.**

From habit of checking to see that keys and adjusting wrenches are removed from tool before turning it on.

9. **Use Right Tool.**

Use the tool for the proper work against its power and intended purpose.

10. Dress Properly.

Do not wear loose clothing or jewelry. They can be caught moving parts.

Wear protective hair covering to contain long hair.

11. Use Safety Glasses.

Also use face or dust mask if operation is dusty.

12. Don't Abuse Cord.

Never carry tool by cord or yank it to disconnect from receptacle.

Keep cord from heat, oil and sharp edges.

13. Don't Overreach.

Keep proper footing and balance at all times.

14. Maintain Tools With Care.

Keep tools sharp and clean for better and safer performance.

Follow instructions for lubricating and changing accessories.

To use the tool for long time safely, perform the periodical inspection for the tool and if damaged, it must be repaired by authorized service facility.

Keep hand dry, clean and free from oil and grease.

Inspect extension cords periodically and replace if damaged.

15. Disconnect Tools.

When not in use such as attaching and detaching the bit, changing the Carbon Brush, inspection or cleaning, etc., disconnect tool.

16. Avoid Unintentional Starting.

Be sure switch is off when plugging in.

Don't carry tool with finger on switch.

16A. Extension Cords.

Make sure your extension cords is in good condition. When using an extension cord, be sure to use one heavy enough to carry the current your product will draw. An undersized cord will cause a drop in line voltage resulting in loss of power and over heating. Table 1 (See Table 1) shows the correct size to use depending on cord length and nameplate ampere rating. If in doubt, use the next heavier gage. The smaller the gage number, the heavier the cord.

TABLE 1
MINIMUM GAGE FOR CORD SETS^a

Volts		Total Length of Cord in Feet		
120V	0 - 25	26 - 50	51 - 100	101 - 150
240V	0 - 50	51 - 100	101 - 200	201 - 300

AWG

Ampere Rating					
More Than	Not More Than				
0	- 6	18	16	16	14
6	- 10	18	16	14	12
10	- 12	16	16	14	12
12	- 16	14	12	Not Recommended	

^a Only the applicable parts of the Table needs to be included. For instance, a 120-volt product need not include the 240-volt heading.

17. Stay Alert.

Watch what you are doing. Use common sense. Do not operate tool when you are tired.

18. Check Damaged Parts.

Before further use of the tool, a guard or other part that is damaged should be carefully checked to determine that it will operate properly and perform its intended function. Check for alignment of moving part, binding of moving parts, breakage of parts, mounting and any other conditions that may affect its operation.

A guard or other part that is damaged should be properly repaired or replaced by an authorized service man or authorized service facility unless otherwise indicated elsewhere in this instruction manual.

19. Outdoor Use Extension Cords.

When tool is used outdoors, use only extension cords intended for use outdoors and so marked.

GROUNDING INSTRUCTIONS

The tool should be grounded while in use to protect the operator from electric shock.

The tool is equipped with a three-conductor cord and three-prong grounding-type plug to fit the proper grounding-type receptacle.

The green (or green and yellow) conductor in the cord is the grounding wire.

Never connect the green (or green and yellow) wire to a live terminal.

If your unit is for use on less than 150 V, it has a plug that looks like that shown in Figure 1.

An adapter (see Figure 3) is available for connecting Figure 1-Type Plug to 2-prong receptacles.

The green colored rigid grounding strap must be connected to permanent ground such as to a properly grounded outlet box.

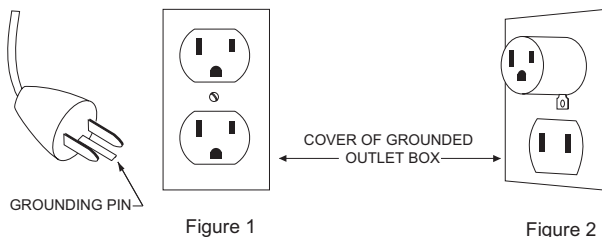

Figure 1

Figure 2

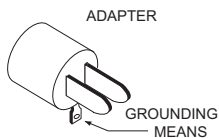

Figure 3

For safe use of adapters, the outlet box must be grounded. If there is any doubt, have a qualified electrician check connections.

Use only 3-wire extension cords that have 3-prong grounding type plugs and 3 pole receptacles that accept the controllers plug. Replace or repair damaged cords.

CAUTIONS IN OPERATION

1. This Screw Driver is integral unit consisting of Screw Driver parts and cord parts.
If any trouble occur, don't take a part off the tool. Stop the operation and have the repair it immediately.
2. Never lubricate aerosol oil and the like. Otherwise it may cause the expensive repair.
3. Do not drop, hit or abuse the tool. Otherwise it may cause some trouble such as crack or damage.
4. Never use the chemicals to wipe the body cover.
5. Use under the proper voltage. Never use under the higher voltage.
6. Do not pull the AC cord when unplug the AC plug. Otherwise it may cause the breaking of wire.
7. To avoid trailing the AC cord on floor, use the Spring Balancer to hang the AC cord.
8. For the safety use, do not set the torque adjusting nut at higher than 10 on the torque adjusting scale. (Ref. to P.14)
9. Use the tool intermittently which describes on the tool: (ex: 0.5 sec. on / 3.5 sec. off)
10. Do not tighten more than 900 pcs of tapping screws per 60 minutes.
11. This tool is not for tightening up wood screw.
12. During the motor is running, never change the forward ←→ reverse direction immediately.
13. Whenever the tool is not in use, set the start switch and Forward/off/Reverse switch to "OFF" position and unplug the AC cord plug.
14. Use of model VZ-4506PS at high torque settings brings a very high impact to the operator's hand. Please use this tool with caution, as Carpal Tunnel Syndrome (CTS) or other trauma disorders may result.

HIOS shock-Resistant Stand is available to absorb the torque to the operator's hand during operation.

SUMMARY

This VZ Series Screw Driver is a Control Function Built-in Type.

The body is light and designed to decrease the vibration and noise.

It is possible to use hexagonal bit with opposite side of 6.35 mm (1/4 inch. HEX.)

Also, you can select the starting system (Lever Start and Push to Start) in accordance with the work.

■ Specifications

VZ Series (PS-type)

Model		VZ-1510 VZ-1510PS	VZ-1820 VZ-1820PS	VZ-3012 VZ-3012PS	VZ-4506 VZ-4506PS
Input		AC 100V	AC 120V	AC 120V	AC 120V
Power Consumption		26W	60W	60W	60W
Output Torque Range	N • m	0.15 - 1.5	0.4 - 1.8	0.9 - 3	1 - 4.5
	lbf • in	1.3 - 13	3.5 - 16	7.8 - 26	8.8 - 39
	(kgf • cm)	(1.5 - 15)	(4 - 18)	(9 - 30)	(10 - 45)
Torque Switching		Stepless adjustment			
Unloaded Rotation Speed (r.p.m) ±10%		1,000	2,000	1,200	600
Screw Size	Small Size Screw	2.0 - 4.0	2.6 - 4.0	3.0 - 5.0	3.0 - 5.0
	Tapping Screw	2.0 - 3.0	2.6 - 3.0	3.0 - 4.0	2.6 - 4.0
Dimensions (mm)	Grip Diameter	∅33	∅37.8	∅37.8	∅37.8
	Total Length	255(243)	276(280)	276(280)	276(280)
Bit Drive	HIOS Shank	H4	H5 & 5HEX	H5 & 5HEX	—
	Hexagonal Shank	5HEX or 1/4HEX	1/4HEX	1/4HEX	1/4HEX
*Weight (g)		497(502)	660(660)	660(660)	660(660)
Power Cable (m)		3	3	3	3

*: Numeric data in () is weight of push-to-start driver.

1. Parts Name

Lever start

Push to start

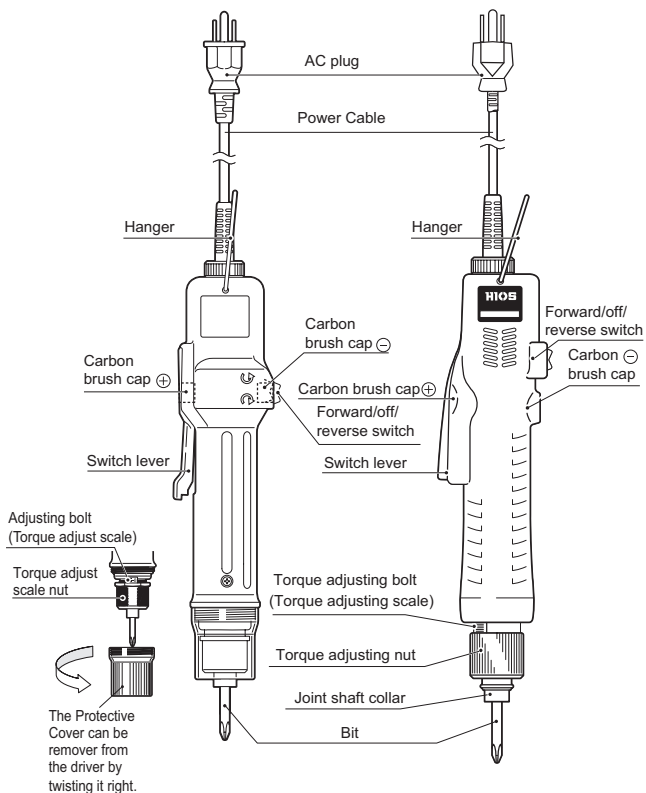

AC 100V

VZ-1510

AC120V

VZ-1820

VZ-3012

VZ-4506

ACCESSORIES

- Bits
- Torque adjusting spring (for VZ-1510, VZ-1510PS)
- Carbon brushes (Not applicable to VZ-1510, VZ-1510PS)
- Screw for adjustment M 2.6 (Phillips screw) for VZ-1820, VZ-1820PS, VZ-3012, VZ-3012PS
- 3PIN to 2PIN power cable adaptor is attached (for VZ-1510, VZ-1510PS)

HOW TO USE

■ OPERATION

1. Insert the Bit into the Joint Shaft Collar of the Screwdriver.
2. Turn the Torque Adjusting Nut and adjust the tightening torque.
3. Make sure the Forward/Off/Reverse Switch is in the "OFF" position.
4. Insert the AC Plug into the AC 120V socket.
5. Set the Forward/Off/Reverse Switch at the "FORWARD" position.

(Caution)

Whenever the direction of rotation is changed, make sure the Forward/Off/Reverse Switch is in the "OFF" position.

6. Fit the Bit to the recession of a screw head, then push the Switch Lever to start the motor.
 - Push to Start System... Motor automatically starts by pressing the tip of Bit against the recession of a screw head.
7. The clutch will automatically stop the rotation of motor when the torque reaches to the fixed value.
Release the Switch Lever to put the Bit off the screw. By the repeat of these operation, screw is tightened continuously.
 - Push to Start System is automatically released by moving the Bit away from screw head.
8. To loosen the tightened screw, turn the Forward/Off/Reverse Switch to "REVERSE" position.
 - When the screw can not be loosened, tighten up the Torque Adjusting Nut.

■ Push-to-Start Type

Both the models of Driver have Push-to-Start type that is designed to start by causing a proper thrusting pressure on the bit in place of pressing the Switch Lever by the forefinger. Drivers of this type are identified by the additional sign PS following the principal Push-to-Start type models. The PS type, therefore, has no lever for starting. All other functions remain same as the principal type.

Users of this type is specifically cautioned to disconnect the cord to shut off power when handling the Quick Change Collet for replacing bit to avoid danger from surprising starting.

Attaching the driver bit



Caution

Always move the driver normal/reverse selector switch to the "OFF" position, or remove the drive power plug from the power outlet so that it is not powered when attaching or removing driver bits.

Please take note that if the push-start driver is powered, even the slightest push can cause the driver to rotate and cause unexpected injuries.

- To attach the driver bit, push the joint shaft collar down towards the driver body and insert the driver bit. Check that the driver bit is firmly locked after it has been attached.

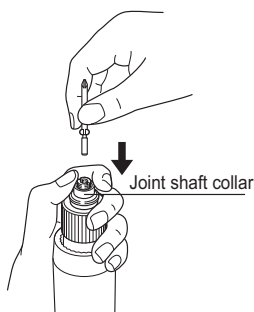

- The VZ-1820 series and VZ-3012 series has a chuck to suit both the HIOS shank H5 ($\varnothing 5$) and the 5 mm wide hexagonal bit (5HEX). Take note of the following precautions when using the hexagonal bit.
- Always use our standard HIOS shank type bits H4 ($\varnothing 4$) and H5 ($\varnothing 5$).

Types of driver bits that can be used with the VZ-1820 series and VZ-3012 series

HIOS Driver Bit H5 ($\varnothing 5$)

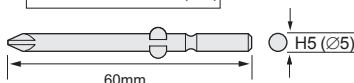

5mm wide Hexagonal W Bit

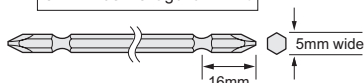

(Caution)

When using the HIOS driver bit $\varnothing 5$ or 5 mm wide Hexagonal W Bit, check that the Phillips adjustment screw within the driver body has not been tightened.

*If the Phillips adjustment screw has been tightened the driver bit may drop out.

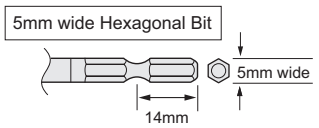

(Caution)

When using the 5 mm wide Hexagonal W Bit, tighten the Phillips adjustment screw (supplied screw) tightly into the driver bit chuck.

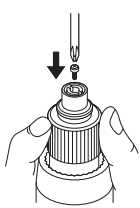

* If the Phillips adjustment screw is not tightened for enough, the driver bit will not be locked and may result in unreliable screw fastening.

Use the Phillips adjustment screw (M 2.6)



Tighten the Phillips adjustment screw properly

■ Types of driver bits that can be used with the VZ-4506 and VZ-4506PS.

- For safe operation use bits conforming to the standards indicated in the diagram on the left below. The diagrams on the right indicate bits that cannot be used with the Screw driver.

Bits for use

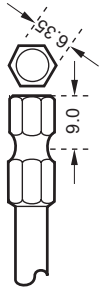

Use size 6.35 mm hexagonal bits whose length from the point to the bearing groove are 9 mm.

Bits unsuitable for driver



Double recess bearing groove

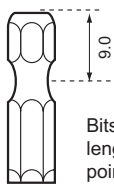

Bits whose length from the point to the bearing groove is not 9 mm.



W bit

■ How to adjust the torque

The Torque Adjusting Scale does not indicate the torque value directly. The torque value of each scale is indicated by the Approximate Guidance of Output Torque on P.14.

Sometimes, there may be difference between fixed value and actual tightening torque by the condition of screw and materials. Please use this Approximate Guidance to get the approximate torque value.

- (1) Referring the Approximate Guidance of Output Torque, decide the position of Torque Adjusting Nut in the Torque Adjusting Scale.
- (2) Rotate the Torque Adjusting Nut and set the right upper of decided graduation.
- (3) Start the motor and tighten the screw. Check the condition of tightening screw.
- (4) If the tightening is not enough, tighten up the Torque Adjusting Nut.

In case of opposite, loosen it. Repeating the adjustment, find the most suitable point.

- The VZ-1510 (VZ-1510PS) Electric Screwdriver have 'Double nut system' (Nut fixing ring and Torque adjusting nut) to avoid loosening from shock or vibration to the driver. To adjust those two nuts, follows (1) to (3) steps below.

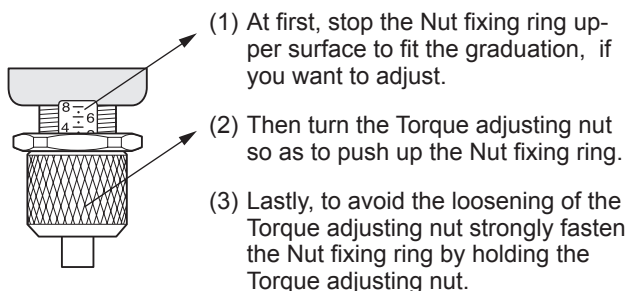

■ We recommend to use the HIOS Torque meter Tools to set the torque of Screw Driver or to check the torque of screw. (HP, HDP series)

- To set the torque of Electric Screw Driver or to check the measurement tools (Torque Driver, etc.) ... HP Type
- To measure the loosening torque or tightening torque ...HDP Type

■ How to change the Carbon Brush

(Caution)

Whenever changing the Carbon Brush, AC plug should be unplugged.

- Unscrew the slotted Carbon Brush Cap by Slotted Screw (-) Driver and remove it.
- When the Carbon Brush Cap is changed, pay attention to the direction of brush surface (concavity). Insert the Brush to fit its surface to the Commutator's.
- Slot on the side of Carbon Brush indicates Limit for Use. Change the Brush when it is abraded over the Slot. To keep the good condition, we recommend to change it earlier.
- Be careful so as not to tighten the Carbon Brush Cap too strongly.

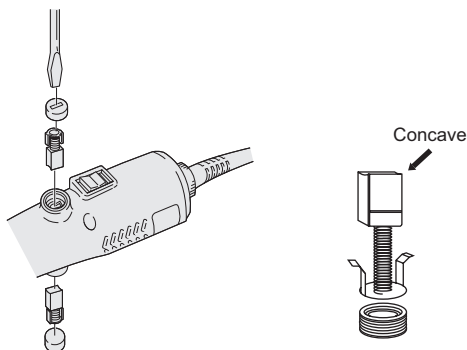

■ List carbon brushes and compatible screwdriver (1 pair = 2pcs)

Applicable models	VZ-1510 (including PS type)	VZ-1820, VZ-3012, VZ-4506 (including PS type)
Oder Cord	ACL10-0490	VZ18-0480
Voltage	AC100V	AC120V

■ Approximate Guidance of Output Torque

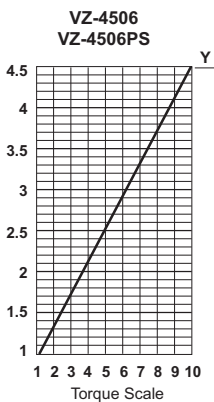
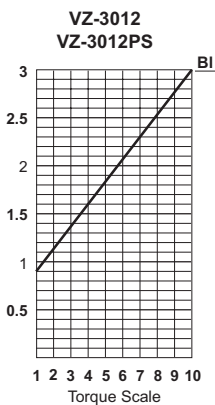
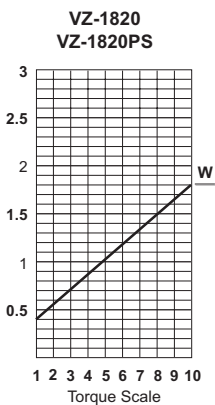
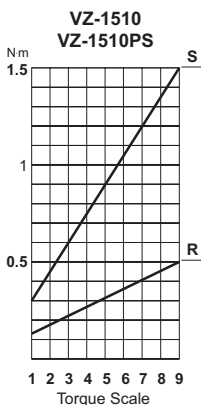
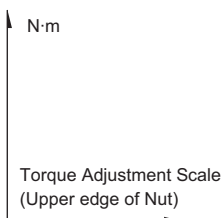

S: Silver
R: Red
Bl: Black
W: White
Y: Yellow